



pan-Canadian FHIR Exchange (CA:FeX) Interoperability Specifications

Version: 2.0.0

Type: Draft

Release Date: December 15, 2023



Canada Health Infoway

Table of Contents

1	CA:FeX Interoperability Specifications.....	5
1.1	Introduction	5
1.2	Intended Audience.....	5
1.3	Purpose.....	5
1.4	Glossary of Terms and Acronyms.....	6
1.5	Preface.....	14
1.5.1	Context	15
1.5.2	Introduction to IHE	15
1.5.3	How to Read This Document	16
1.5.4	Document Conventions	17
1.5.5	Requirements Language.....	17
1.5.6	Methodology	17
1.5.7	Introduction to a Use-Case Driven Approach	17
1.5.8	Release Cycle.....	18
1.6	Privacy & Security Guidance.....	18
1.6.1	Privacy Considerations	18
1.6.2	Security Considerations.....	18
1.7	CA:FeX Use Case Overview.....	19
1.7.1	Use Case Overview	19
1.7.2	In-Scope.....	19
1.7.3	Use Case Actors and Services	19
1.8	Core Interoperability Specification Requirements	20
1.8.1	Actor Mapping to Interoperability Specification	20
1.8.2	Table 1 Interoperability Conformance Requirements for Use Case 1: Create and Submit Document.....	21
1.8.3	Table 2 Interoperability Conformance Requirements for Use Case 2: Query and Retrieve Document.....	23
1.8.4	Table 3 Interoperability Conformance Requirements for Use Case 3: Create and Submit Data	25
1.8.5	Table 4 Interoperability Conformance Requirements for Use Case 4: Query and Retrieve Data	26
1.8.6	Table 5 Interoperability Conformance Requirements for Use Case 5: Fetch Document References	28
1.9	Actor Conformance	29
1.9.1	Constraints on Use Case Actors.....	30
1.10	CA:FeX Actors and Transactions.....	34

1.11	CA:FeX Sequence Diagrams	34
1.11.1	Sequence Diagram for UC-01: Create and Submit Document	35
1.11.2	Sequence Diagram for UC-02: Query and Retrieve Document	36
1.11.3	Sequence Diagram for UC-03: Create and Submit Data.....	38
1.11.4	Sequence Diagram for UC-04: Query and Retrieve Data	39
1.11.5	Sequence Diagram for UC-05: Fetch Document References.....	40
1.12	CA:FeX Cross Profile Considerations	42
1.12.1	Consistent Time (CT) Grouping	42
1.12.2	Internet User Authorization (IUA) Grouping	43
1.12.3	Canadian Network Security (CA:Sec) Grouping.....	44
1.12.4	Canadian Audit Trail (CA:Aud) Grouping.....	44
1.13	CA:FeX Audit Considerations	45
1.13.1	Submit Data [CA:FeX-1] Audit	45
1.13.2	Search Data [CA:FeX-2] Audit.....	49
1.13.3	Retrieve Data [CA:FeX-3] Audit	53
2	Use Cases and Definitions	58
2.1	Use Case Index	58
2.2	Requirement Priority Definitions	59
2.3	UC-01 Create and Submit Document.....	59
2.4	UC-02 Query and Retrieve Document	63
2.5	UC-03 Create and Submit Data.....	66
2.6	UC-04 Query and Retrieve Data	70
2.7	UC-05 Fetch Document References.....	73
3	Exchanging Data & Documents in FHIR	79
3.1	Overview	79
3.2	Transactions.....	79
3.3	FHIR Version	82

Version	2.0.0
Type	Draft
Release Date	December 15, 2023

This version of the CA:FeX is referenced by and/or references the following Interoperability products:

- pan-Canadian Patient Summary Interoperability Specifications ([PS-CA v1.1.0 DFT-Ballot](#))
- Reference Architecture ([RA v0.1.1 DFT](#))

1 CA:FeX Interoperability Specifications

1.1 Introduction

Interoperability enables information to flow seamlessly between different solutions and devices. When different parts of the health care system are interoperable with each other, they can “speak the same language.”

Interoperability improves continuity of care, collaboration between health care providers and patient access to their health information. By breaking down data silos, it also reduces inefficiencies and redundancies within the health care system.

Connection, collaboration and communication have never been more important for the healthcare system. Increased use of digital health solutions within healthcare has highlighted the need for safe and efficient electronic sharing of information across the circle of care. Continuing to improve Canadian healthcare will necessitate work in interoperability — connected systems are healthier systems.

In support of the provinces and territories, Canada Health Infoway (Infoway) is facilitating a national collaborative effort to advance interoperability. While there are many interoperability-related challenges, this specification addresses standardized sharing of vital patient information for the benefit of healthcare providers and patients using FHIR based information exchange. This FHIR based information exchange is similar to and accomplishes the same objectives as a Health Information Exchange (HIE).

The [Office of the National Coordinator for Health Information Technology](#) (ONC) defines HIE as:

Electronic health information exchange (HIE) allows doctors, nurses, pharmacists, other health care providers and patients to appropriately access and securely share a patient’s vital medical information electronically—improving the speed, quality, safety and cost of patient care.

While electronic health information exchange cannot replace provider-patient communication, it can greatly improve the completeness of patient’s records, (which can have a big effect on care), as past history, current medications and other information is jointly reviewed during visits.

Appropriate, timely sharing of vital patient information can better inform decision making at the point of care and allow providers to avoid readmissions, avoid medication errors, improve diagnoses and decrease duplicate testing.

1.2 Intended Audience

The intended audience of the CA:FeX Interoperability Specifications (Canadian FHIR Exchange (CA:FeX)), includes but is not limited to:

- Those interested in integrating healthcare information systems and workflows;
- IT departments of healthcare institutions;
- Technical staff of clinical solution vendors;
- Experts involved in standards development; and
- Software developers.

1.3 Purpose

The purpose of this document is to address the following functionality for release 2:

- Address five FHIR HIE use cases;

- Provide a detailed set of requirements (including actors, transactions and references to specific profiles and standards);
- Describe the implementation patterns that enable the exchange of clinical information using CA:FeX; and
- Describe the set of requirements that complement the set of IHE Profiles and HL7 FHIR® Profiles required by the CA:FeX specifications with Canadian specific constraints.

1.4 Glossary of Terms and Acronyms

The following table provides a list of terms and acronyms that you may encounter throughout the pan-Canadian interoperability specifications (e.g. PS-CA, CA:FeX) and/or in the prototyping and validation information.

Term / Acronym	Meaning
ATNA	The Audit Trail and Node Authentication (ATNA) Profile specifies the foundational elements needed by all forms of secure systems: node authentication, user authentication, event logging (audit), and telecommunications encryption. It is also used to indicate that other internal security properties such as access control, configuration control, and privilege restrictions are provided. (Source: https://profiles.ihe.net/ITI/TF/Volume1/ch-9.html)
Author (e.g., PS-CA Author)	A health care provider who authors and/or curates clinical data (e.g. Patient Summary).
Business/Legal Interoperability Requirements	Requirements that enable independent organizations to execute a collaborative process or service.
Business Requirements: Non-Testable	Business requirements that are not directly traceable to an IHE profile in the PS-CA specifications (e.g., provided for consideration and to support and provide guidance to implementers of the PS-CA).
Business Requirements: Testable	Business requirements that are directly traceable to an IHE profile in the PS-CA specifications.
CA:FeX	The CA:FeX Interoperability Specifications (Canadian FHIR Exchange (CA:FeX)) seek to promote FHIR RESTful exchange patterns, developed by industry-leading FHIR standards that can be applied on top of an existing non-FHIR infrastructure just as easily as it can be applied on top of FHIR servers.
CA:FMT	Canadian Formatting Service (CA:FMT) is a Canadian Integration Specification that provides formatting support service. It provides support for transformation of documents between different formats (e.g. from FHIR to PDF, CDA, etc.).
CCDD	The Canadian Clinical Drug Data Set (CCDD) is the drug terminology for use in digital health solutions such as electronic prescribing in Canada.

Term / Acronym	Meaning
Central Infrastructure	A Central Infrastructure collects health information from participating organizations and stores the information in a centralized place. The Infrastructure also provides access control. Typically, the Central Infrastructure is under jurisdictional control.
Clinical Data Repository (Local or Central)	A Clinical Data Repository (i.e., document repository) is a shared storage space for clinical documents that can be hosted locally (e.g., at the data producer) or at the Central Infrastructure and can be accessed by authorized users.
Clinical Solution	Any combination of health information technology assets and processes that enables clinical data to be communicated, managed, and dispositioned between a Producer and a Consumer. Clinical Solutions can be comprised of various Producer and Consumer systems including: EMR, HIS, CIS, PHR, EHR or any combination of these systems.
Conformance Testing	Conformance testing is a formal process of assessment focused on ensuring clinical solutions and systems accurately implement a particular specification (e.g. PS-CA Specifications) by ensuring there is conformance to the stated parameters that are being claimed in the standard.
Consumer (e.g., PS-CA Consumer)	A health records system (e.g., EMR, HIS, CIS, PHR, Patient Portal or EHR) that enables access to or receipt of a clinical document (e.g. PS-CA) by an authorized health care provider or the subject of care/patient.
Cross Border, Scheduled Care	Scheduled care of a resident of Canada that is delivered in/by another country.
Cross Border, Unscheduled Care	Unscheduled care of a resident of Canada that is delivered in/by another country.
CT	The Consistent Time Integration Profile (CT) provides a means to ensure that the system clocks and time stamps of the many computers in a network are well synchronized. This profile specifies synchronization with a median error less than 1 second. This is sufficient for most purposes. (Source: https://profiles.ihe.net/ITI/TF/Volume1/ch-7.html)
DIN	A Drug Identification Number (DIN) is a computer-generated eight digit number assigned by Health Canada to a drug product prior to being marketed in Canada.
Document Repository (Local or Central)	See Clinical Data Repository (Local or Central)
DPD	The Drug Product Database (DPD) is used to find drugs authorized for sale by Health Canada. The DPD is updated nightly and includes availability of the drug in Canada.

Term / Acronym	Meaning
Electronic Health Record (EHR)	<p>The EHR represents the Clinical Solution that contains a secure and private collection of a patient's health information in a digital format, which is shareable across different health care settings / clinical solutions that are integrated. The EHR facilitates better sharing and interpretation of health information among the health care professionals involved in the care of the patient. For example:</p> <ul style="list-style-type: none"> • CareConnect is British Columbia's secure, view-only EHR solution. It offers healthcare providers access to an integrated, provincial view of patient-centric information available 24/7 to support the delivery of patient care. • HEALTHe NL is the Newfoundland & Labrador provincial EHR. HEALTHe NL will provide more accurate and reliable data to support improved health care delivery, decision-making and policy and create improved accountability, stability and efficiency in the provincial health care system. • Netcare is Alberta's name for all the projects related to the provincial EHR - a secure and confidential electronic system of Alberta patients' health information: a single, comprehensive, and integrated patient record. • Other clinical systems: In some health authorities, other clinical systems may act as an EHR, holding the patient summary information.
Extensible PS-CA Dataset	<p>Extensible PS-CA Dataset: PS-CA content that can be extended for use in a PS-CA use case scenario that complements the primary PS-CA use cases.</p> <p>*Note: Extensible PS-CA Dataset refers to the addition of data domains such as Family History.</p>
FHIR® Repository	<p>A FHIR repository is a clinical data repository built around the HL7® FHIR® standard used for storing clinical data.</p>
Gazelle	<p>Gazelle is a suite of virtual tools, developed by IHE Europe used to support interoperability testing. Gazelle will allow jurisdictions and vendors an opportunity to validate the role they will be playing in an ecosystem and ensure they are able to satisfy the interoperability requirements. Gazelle offers several self-serve, self-test and innovation opportunities for jurisdictions and vendors to test their alignment to the represented integration profiles.</p>
HCP	<p>Health Care Provider</p>
Health Information Access Layer (HIAL)	<p>An interface specification for the EHR infostructure that defines service components, service roles, information model and messaging standards required for the exchange of EHR data and execution of interoperability profiles between EHR services.</p> <p>(Source:https://www.infoway-inforoute.ca/en/component/edocman/resources/technical-documents/391-ehrs-blueprint-v2-full ; Page.340)</p>

Term / Acronym	Meaning
Health Information Exchange (HIE)	<p>Electronic health information exchange (HIE) allows doctors, nurses, pharmacists, other health care providers and patients to appropriately access and securely share a patient's vital medical information electronically—improving the speed, quality, safety and cost of patient care.</p> <p>While electronic health information exchange cannot replace provider-patient communication, it can greatly improve the completeness of patients' records, (which can have a big effect on care), as past history, current medications and other information is jointly reviewed during visits.</p> <p>Appropriate, timely sharing of vital patient information can better inform decision making at the point of care and allow providers to avoid readmissions, avoid medication errors, improve diagnoses and decrease duplicate testing.</p> <p>(Source: https://www.healthit.gov/topic/health-it-and-health-information-exchange-basics/what-hie)</p>
Health Records System	<p>A health records system may include an electronic medical records system, a hospital information system, a clinical information system, an electronic health records system or a personal health records system. The term is broadly used to describe system actors that may produce and/or consume a PS-CA. Jurisdictional implementation patterns will determine which systems are used to create, access, consume and manage patient summaries.</p>
HIS	Health Information System
Health Level 7 (HL7®)	<p>Founded in 1987, HL7 is a not-for-profit standards developing organization dedicated to providing a comprehensive framework and related standards for the exchange, integration, sharing, and retrieval of electronic health information that supports clinical practice and the management, delivery and evaluation of health services.</p> <p>(Source: http://www.hl7.org/about/index.cfm?ref=nav)</p>
HL7® Fast Healthcare Interoperability Resources (FHIR®)	<p>Expected to be a next generation standards framework created by HL7. FHIR® combines the best features of HL7's Version 2, Version 3 and product lines while leveraging the latest web standards and applying a tight focus on implementability.</p> <p>(Source: http://www.hl7.org/implement/standards/fhir/)</p>
Information/Semantic Interoperability Requirements	<p>Requirements for syntax and semantics such that data exchanged between health record systems can be interpreted and the meaning of the data ascertained.</p>

Term / Acronym	Meaning
Integrating the Healthcare Enterprise (IHE)	<p>IHE is an initiative by healthcare professionals and industry to improve the way computer systems in healthcare share information. IHE promotes the coordinated use of established standards such as DICOM and HL7 to address specific clinical needs in support of optimal patient care. Systems developed in accordance with IHE communicate with one another better, are easier to implement, and enable care providers to use information more effectively.</p> <p>(Source: https://www.ihe.net/)</p>
IHE Actor	<p>IHE Actors are responsible for producing, managing and/or acting on information in the context of an IHE Profile (e.g., Primary Care Provider, EMR, EHR, etc.).</p> <p>(Source: https://wiki.ihe.net/index.php/Actors)</p>
IHE Domain	<p>IHE Domains are responsible for the development and maintenance of the IHE Technical Frameworks that document the Integration Profiles. Each Domain manages Integration Profiles in a particular part of healthcare (e.g., Virtual Care).</p> <p>(Source: https://wiki.ihe.net/index.php/Domains)</p>
IHE Integration Profiles	<p>IHE Integration Profiles provide a solution to the interoperability challenges which have arisen in daily clinical work, as described in the Use Cases. Integration Profiles include detailed technical specifications for the use and implementation of relevant standards thus ensuring an uninterrupted flow of information between different healthcare IT applications in support of the specific use case.</p> <p>The Profiles describe how healthcare IT systems can provide integrated support for a clearly defined workflow, each of which individually supports a clinical task within a specific clinical domain. IHE Profiles can be used for a step-by-step implementation of systems in different domains and the gradual building of interoperable eHealth applications.</p> <p>(Source: https://www.ihe-europe.net/about-us/faq)</p>
IHE Transactions	<p>IHE Transactions are interactions between actors that communicate the required information through standards-based messages (e.g., patient look-up query, send patient summary information, etc.).</p> <p>(Source: https://wiki.ihe.net/index.php/PCC_TF-1/About)</p>
International Patient Summary (IPS)	<p>The IPS is a minimal, non-exhaustive set of data elements defined by ISO/EN 17269 and realized by HL7 in both CDA and FHIR. The IPS is a snapshot clinical document that can be used for planned or unplanned care of a person locally or across borders. It emphasizes the data required and the necessary conformance of the use cases for an international patient summary.</p> <p>(Source: https://wiki.ihe.net/index.php/International_Patient_Summary_(IPS))</p>

Term / Acronym	Meaning
Interoperability	<p>Interoperability enables information to flow seamlessly between different solutions and devices. When different parts of the health system are interoperable with each other, they can “speak the same language.” Interoperability improves continuity of care, collaboration between health providers and patient access to their health information. By breaking down data silos, it also reduces inefficiencies and redundancies within the health system.</p> <p>Connection, collaboration and communication have never been more important for the health system. Increased use of virtual care has highlighted the need for safe and efficient electronic sharing of information across the circle of care. Continuing to improve Canadian health care will necessitate work in interoperability — connected systems are healthier systems.</p> <p>For more information about interoperability, please visit Canada Health Infoway - Interoperability.</p>
IUA	<p>The Internet User Authorization (IUA) Profile provides support for authorizing network transactions when using HTTP RESTful transports. IHE has authorization profiles for the Web Services and SOAP based transactions, and this profile provides an authorization profile for the HTTP RESTful transactions.</p> <p>(Source: https://profiles.ihe.net/ITI/TF/Volume1/ch-34.html)</p>
Local, Scheduled Care	<p>Scheduled care of a resident of Canada that is delivered in/by the Canadian health care system. This includes care provided in federal, provincial and territorial jurisdictions, as well as cross-jurisdictional care.</p>
Local, Unscheduled Care	<p>Unscheduled care of a resident of Canada that is delivered in/by the Canadian health care system. This includes care provided in federal, provincial and territorial jurisdictions, as well as cross-jurisdictional care.</p>
Longitudinal Electronic Health Record	<p>A longitudinal electronic health record is a single comprehensive patient record comprised of data from numerous data sources across the healthcare continuum.</p>
Medical Home	<p>The College of Family Physicians of Canada describes the Medical Home as:</p> <p>"The Patient's Medical Home (PMH) is a family practice defined by its patients as the place they feel most comfortable—most at home—to present and discuss their personal and family health and medical concerns. It is the central hub for the timely provision and coordination of a comprehensive menu of health and medical services patients need."</p> <p>To read more about the Patient's Medical Home, please visit The College of Family Physicians of Canada's published document, A Vision for Canada - Family Practice - The Patient's Medical Home.</p>

Term / Acronym	Meaning
MHD	<p>The Mobile access to Health Documents (MHD) Profile defines one standardized interface to health document sharing (a.k.a. an Application Programming Interface (API)) for use by mobile devices so that deployment of mobile applications is more consistent and reusable.</p> <p>(Source: https://profiles.ihe.net/ITI/MHD/index.html)</p>
Patient Portal	<p>A patient portal is a web-based access point that enables secure patient access to personal health information and other self-serve health IT services. For example, a patient portal can be hosted on an EMR solution.</p>
Patient Proxy	<p>An individual or entity that has the authority to act on behalf of a subject of care/patient. Proxies can include parents of dependent children, parents of dependent adults, powers of attorney, etc.</p>
Patient Summary-CA (PS-CA)	<p>An electronic patient summary for use at the point of care comprised of, at minimum, the required elements of the Patient Summary-CA data set and specifications. The PS-CA is a health record extract, at a snapshot in time, comprised of a standardized collection of clinical and contextual information (retrospective, concurrent, prospective), including the minimum necessary and sufficient data to inform a patient's treatment at the point of care. The PS-CA is condition-independent and specialty-agnostic, irrespective of the condition of the patient or the treatment sought or specialty of the provider delivering care.</p>
PDQm	<p>The Patient Demographics Query for Mobile (PDQm) Profile defines a lightweight RESTful interface to a patient demographics supplier leveraging technologies readily available to mobile applications and lightweight browser based applications.</p> <p>(Source: https://profiles.ihe.net/ITI/TF/Volume1/ch-38.html)</p>
PIXm	<p>The Patient Identifier Cross-reference for Mobile (PIXm) Profile provides RESTful transactions for mobile and lightweight browser-based applications to create, update and delete patient records in a Patient Identifier Cross-reference Manager and to query the Patient Identifier Cross-reference Manager for a patient's cross-domain identifiers.</p> <p>(Source: https://profiles.ihe.net/ITI/TF/Volume1/ch-41.html)</p>
PMIR	<p>The Patient Master Identity Registry (PMIR) Profile supports the creating, updating and deprecating of patient master identity information about a subject of care, as well as subscribing to changes to the patient master identity, using the HL7 FHIR standard resources and RESTful transactions.</p> <p>(Source: https://www.ihe.net/uploadedFiles/Documents/ITI/IHE_ITI_Suppl_PMIR.pdf)</p>
Producer (e.g., PS-CA Producer)	<p>A health records system (e.g., EMR, HIS, CIS, PHR, or EHR) that creates/produces a clinical document (e.g. PS-CA) in response to a request from an authorized health care provider, the subject of care or another authorized health records system.</p>

Term / Acronym	Meaning
Projectathon	A Projectathon is an important step and a best-practice approach in testing and validation of a specification package, where implementers collaborate to test their solutions using methodology and tools that accelerate interoperability. A Projectathon provides an opportunity for participants to test their systems among themselves and against a reference environment. It is also an opportunity to collaborate among peers to enable hands-on knowledge exchange.
PS-CA Solution	Any combination of health information technology assets and processes that enables a Patient Summary-CA to be created, communicated, managed and dispositioned between a PS-CA Producer and a PS-CA Consumer. Patient Summary-CA Solutions can be comprised of various Producer and Consumer systems including: EMR, HIS, CIS, PHR, EHR or any combination of these systems.
PS-CA Specifications	pan-Canadian Patient Summary Interoperability Specifications: The pan-Canadian Patient Summary Interoperability Specification is an implementable, testable specification, based on the IHE International Patient Summary specification and the HL7 IPS Implementation Guide. For more information on the PS-CA Specifications, please go here .
PT	Provinces and Territories
RA	The Reference Architecture (RA) is intended as an evolving blueprint of service availability that supports a broader interoperability landscape, not limited to patient summaries. Its purpose is to facilitate multi-stakeholder dialogue, collaboration and convergence towards common, open standards. It is a conceptual technical view that provides a common vocabulary and a set of actors and transactions representing typical components in a digital health ecosystem (public and private sector solutions). It is combination of building blocks adopted from international standards development bodies and Canadian developed implementation patterns.
SUT	System Under Test
SVCM	Sharing Valuesets, Codes and Maps (SVCM) defines a lightweight interface through which healthcare systems may retrieve centrally managed uniform nomenclature and mappings between code systems based on the HL7 Fast Healthcare Interoperability Resources (FHIR) specification. (Source: https://wiki.ihe.net/index.php/Sharing_Valuesets,_Codes_and_Maps_(SVCM))
Technical Interoperability Requirements	Requirements for one health record system to send data to another health record system and for the receiving system to acknowledge receipt of the data payload.
Terminology	Collection of uniquely identifiable concepts with associated representations, designations, associations and meanings.

Term / Acronym	Meaning
XDM	Cross-Enterprise Document Media Interchange (XDM) provides document interchange using a common file and directory structure over several standard media types. This permits the patient to use physical media to carry medical documents. This also permits the use of person-to-person email to convey medical documents. XDM supports the transfer of data about multiple patients within one data exchange. (Source: https://profiles.ihe.net/ITI/TF/Volume1/ch-16.html)
XDS	The Cross-Enterprise Document Sharing (XDS) IHE Integration Profile facilitates the registration, distribution and access across health enterprises of patient electronic health records. (Source: https://profiles.ihe.net/ITI/TF/Volume1/ch-10.html)

1.5 Preface

The CA:FeX Interoperability Specifications (Canadian FHIR Exchange (CA:FeX)) seek to promote FHIR RESTful exchange patterns, developed by industry-leading FHIR standards that can be applied on top of an existing infrastructure just as easily as it can be applied on top of FHIR servers.

The current version of CA:FeX is focused on the FHIR RESTful exchange of documents as well as individual resources, which FHIR offers multiple structures and patterns to achieve. CA:FeX aims to provide clarity to implementers by identifying some of the choices currently available using FHIR, ranging from simple to a higher level of sophistication. The scope of CA:FeX will continue to evolve to support a multi-phased CA:FeX roadmap, the evolving needs of the Canadian health care market, and emerging trends within the international FHIR health information exchange community.

CA:FeX seeks to harmonize around global interoperability guidance and well-implemented exchange patterns. For this reason, CA:FeX attempts to identify any established IHE profiles that align to its use cases and requirements. Ideally, these IHE profiles can be implemented directly. However, localization is sometimes needed when legacy profiles do not meet Canadian requirements or when the requirements of legacy profiles need to be further refined to better meet implementer needs.

Upon review of legacy IHE profiles for document exchange, existing guidance is either based on the enablement of document sharing within non-FHIR infrastructures or through the narrow use of FHIR resources. Given the evolving needs of the Canadian market, these legacy profiles may not be entirely sufficient to enable the FHIR RESTful exchange of documents. Two key existing IHE profiles that were contemplated, including some of their limitations, are listed below:

- *Cross-Enterprise Document Sharing (XDS)*: This IHE profile is focused on providing a standards-based specification for the sharing of documents which is limited to non-FHIR infrastructures. Note that, although considered, the XDS profile is not presented as an option within the [Reference Architecture](#), as the Canadian landscape revealed that it is interested in adopting more modern FHIR-based approaches.
- *Mobile access to Health Documents (MHD)*: This IHE profile is designed for the utilization of FHIR standard to communicate and exchange documents, including, as an option, acting as a proxy to systems that use XDS. MHD leverages FHIR resources (i.e., List, DocumentReference) as a standard method for clients to find a document. To ensure this IHE profile can be used without regard for how information is stored (e.g., XDS infrastructure, FHIR, or another storage system) the profile applies constraints to the FHIR List resource and the DocumentReference resource. MHD entails a multi-step document retrieval process (find List, followed by find DocumentReference step, followed by the document retrieval step) which may not be the single approach implementers will take going forward.

Through a market scan, it was observed that in line with MHD, existing RESTful FHIR Implementation Guides that include document exchange (e.g., US Core, IPA, PACIO, IPS, etc.) have begun utilizing a pattern, leveraging the DocumentReference Resource and/or the \$docRef operation. These Implementation Guides, however, enable querying in a single way and return pointers to document content, wherever it is stored and irrespective of the format (e.g., binary or FHIR-assembled). FHIR Search Parameters and FHIR Operations have been developed to augment the capabilities of this pattern to more easily get back what was requested and enable the offering of documents in the expected format without having to change the underlying data model / document and lifecycle practices.

Earlier versions of the CA:FeX specification focused on exploring simpler exchange patterns for submitting and retrieving FHIR documents (from FHIR Document Repositories) using the appropriate FHIR Search Parameters based on the Bundle and Composition Resources. This version expands on that scope to highlight emerging patterns for using DocumentReference Resource and FHIR Operations to find and retrieve documents from Hybrid Document Repositories (i.e., repositories that include a mixture of document types and formats). This still represents a simpler approach (compared to MHD) by removing the requirement for a List resource. As more is known from the trialing of this pattern, it will be assessed for potential refinement of the MHD profile.

This version also includes foundational expectations for exchanging atomic data (individual FHIR resources). The initial use cases involving the exchange of atomic data were well aligned to the IHE Query for Existing Data for mobile (QEDm) profile and may not require further changes to be proposed to QEDm.

The intent of CA:FeX is to support exchange behaviors in pan-Canadian specifications like the [pan-Canadian Patient Summary Interoperability Specifications \(PS-CA\)](#), an implementable, testable specification, based on the IHE International Patient Summary specification and the HL7 IPS Implementation Guide. The PS-CA references the CA:FeX Interoperability Specifications as an optional implementation pattern for submitting, searching and retrieving a Patient Summary document. As pan-Canadian specifications increase, particularly ones that rely on exchange of individual FHIR resources, utilization of CA:FeX is also expected to evolve.

1.5.1 Context

The CA:FeX Interoperability Specifications are published to a public space within Canada Health Infoway's InfoScribe and are also available as a downloadable document, [here](#). InfoScribe is a web-based tool developed for jurisdictions and vendors to create, publish, and collaborate on clinical requirements and specifications for interoperability solutions. Teams can document, share, and discuss content, files, ideas, specs, mock-ups, diagrams, and projects. A link to the online published content and the downloadable documentation will be published with each release of CA:FeX.

1.5.2 Introduction to IHE

Integrating the Healthcare Enterprise (IHE) is an international initiative to promote the use of standards to achieve interoperability among health information technology (HIT) systems and effective use of electronic health records (EHRs). IHE provides a forum for care providers, HIT experts and other stakeholders in several clinical and operational domains to reach consensus on standards-based solutions to critical interoperability issues.

The primary output of IHE is system implementation guides, called IHE profiles. IHE publishes each profile through a well-defined process of public review and Trial Implementation and gathers profiles that have reached Final Text status into an IHE Technical Framework.

1.5.3 How to Read This Document

This document contains the following sections:

Document Section	Description	Target Audience
CA:FeX Interoperability Specifications	CA:FeX is an implementable, testable specification based on HL7 FHIR Implementation Guides. It defines building blocks to enable FHIR Health Information Exchange (HIE) implementation patterns. CA:FeX building blocks are configurable to address necessary Canadian jurisdictional variances. The CA:FeX Interoperability Specifications, written in line with international best practices, contain the information necessary for an implementer to consume and develop the components necessary for creating, consuming and sharing clinical data and may be applied to existing and new information systems.	Solution Developers
Use Cases & Definitions	The Use Cases & Definitions present the broader context for clinical, business, interoperability and solution development considerations that were discovered during the development of the CA:FeX Interoperability Specifications. This section defines the healthcare problem that CA:FeX addresses and includes healthcare use cases and interoperability requirements in terms that will be traceable to the content in the Reference Architecture, which defines the actors and their interactions in scope for the CA:FeX Interoperability Specifications.	CTOs, CMIOs, CIOs, PTs and Vendors
Exchanging Data & Documents in FHIR	The Exchanging Data and Documents in FHIR section points to the CA:FeX FHIR Implementation Guide that contains methods for implementing the CA:FeX transactions specifically for FHIR Resource exchange using FHIR RESTful APIs.	Solution Developers

Within the Pan-Canadian CA:FeX Interoperability Specifications, you can expect the following subsections:

- **Introduction & Preface:** Contains an introduction to the CA:FeX Interoperability Specifications. This section contains a summary of the context, document purpose and scope, as well as other content to help orient the first-time reader to the topic of these specifications and how they relate to other specifications in the digital health ecosystem in Canada.
- **Privacy & Security Guidance:** Provides a reference to Infoway's recently published privacy primer, Privacy as an Enabler, that provides an introduction to interoperability, an overview of Canadian privacy laws and some practical approaches to privacy for interoperability. And, it provides a high-level list of security considerations for the CA:FeX specifications.
- **Use Case Overview:** Describes the Use Cases, including design constraints and assumptions and the flows of information that will be specified in the CA:FeX Interoperability Specifications. This section also references scenarios that describe how the specified flows may be used in the Canadian context.
- **Core Interoperability Specification Requirements:** Establishes the Core Interoperability Requirements for the CA:FeX Interoperability Specifications with respect to a FHIR Health Information Exchange (HIE) implementation pattern. This section also provides mapping of use case actors to the technical actors of the

CA:FeX Interoperability Specifications and the services they are supporting, which are aligned with the flow captured in the sequence diagrams included [here](#).

- **CA:FeX Actor Conformance:** Establishes the Actor Conformance Requirements for the CA:FeX Interoperability Specifications.
- **CA:FeX Actors and Transactions:** Illustrates the abstracted actors and transactions in scope for the CA:FeX Interoperability Specifications.
- **CA:FeX Sequence Diagrams:** Provides guidance on how to apply CA:FeX implementation patterns along with other IHE profiles to address interoperability needs pertaining to FHIR Health Information Exchange (HIE) implementation pattern. They group together actors and transactions from multiple profiles including CA:FeX to address the scope of the use cases.
- **CA:FeX Cross Profile Considerations:** Provides guidance on groupings between the CA:FeX actors with other IHE profiles to achieve additional functionality such as Network Security, Authentication, Authorization, Auditing and more.
- **CA:FeX Audit Considerations:** Provides audit considerations for each of the CA:FeX transactions.

1.5.4 Document Conventions

The CA:FeX Interoperability Specifications will be versioned according to the IO Specifications Publication Model, defined [here](#).

1.5.5 Requirements Language

The following conventions are used to specify requirement levels for the business requirements of the CA:FeX Interoperability Specifications:

- **Shall:** used to indicate a **required** requirement.
- **Should:** used to indicate that a requirement is **recommended** and should be considered as best practice for implementation, but not required (i.e., it is optional) for implementation.
- **May:** used to indicate that a requirement is permissible / **optional**, but not required for implementation.
- **Shall not:** used to indicate that an element or action is prohibited.

Additional information on the CA:FeX business requirements can be found in the Use Cases and Definitions section.

1.5.6 Methodology

The CA:FeX Interoperability Specifications have been developed based on international research and stakeholder consultations with HIE Subject Matter Advisors, where this was socialized and validated with participating jurisdictions and vendors through Coordinating Table Meetings, Executive Table Meetings, stakeholder workshops and 1-on-1 meetings to further refine the specifications.

1.5.7 Introduction to a Use-Case Driven Approach

The following use case-driven approach was utilized in the development of the CA:FeX Interoperability Specifications:

- **Baseline:** Develop foundational Use Cases, Use Case Scenarios and Business Requirements for FHIR Health Information Exchange (HIE).
- **Collaborate:** Collaborate with jurisdictions, clinical SMEs, technical SMEs, vendors, participating organizations to develop and refine detailed artefacts.
- **Review:** Review and provide feedback into artefacts through engagement workshops and input gathering.
- **Publish:** Publish artefacts for broader stakeholder consultation.
- **Recommend:** Recommend draft artefacts for approval.
- **Iterate:** Continue to refine as per testing and priorities.

1.5.8 Release Cycle

The CA:FeX Interoperability Specifications' release cycle includes a multi-stage review and feedback process, as documented [here](#).

1.6 Privacy & Security Guidance

1.6.1 Privacy Considerations

Infoway has developed a privacy primer, Privacy as an Enabler, that provides an introduction to interoperability, an overview of Canadian privacy laws and some practical approaches to privacy for interoperability. It delves into the role privacy plays in the creation of interoperable health systems. It addresses the myth that privacy laws mean patient data can't be shared. The primer outlines how privacy laws enable the sharing of patient data by providing guidance on how to share health data safely, with a patient's consent, and the responsibilities of both parties when patient information is shared.

Download the privacy primer here: [Privacy as an Enabler: Sharing Personal Health Information for Interoperability Primer](#).

1.6.2 Security Considerations

Fast Healthcare Interoperability Resources (FHIR) is not a security protocol, nor does it define any security related functionality. However, FHIR does define exchange protocols and content models that need to be used with various security protocols defined elsewhere.

FHIR transactions defined as part of the CA:FeX implementation pattern often make use of patient-specific information which could be exploited by malicious actors resulting in exposure of patient data. For this reason, all FHIR transactions must be secured appropriately with access to limited authorized individuals, data protected in transit, and appropriate audit measures taken.

Implementers SHOULD be aware of security considerations associated with FHIR transactions (<http://hl7.org/fhir/R4/security.html>), particularly those related to:

- Communications
- Authentication
- Authorization/Access Control
- Audit Logging
- Digital Signatures
- Security Labels
- Narrative

Additionally, many FHIR transactions using HTTP REST will include query parameters that would be identifiers, quasi-identifiers, or sensitive health topics. For example, it is common for patient identifier to be a query parameter. With this URL pattern, the query parameters are typically visible in the server audit log or browser history. The risk from this visibility should be mitigated in system or operational design, by protecting the logs as sensitive data, or by designing other measures into the system to prevent inappropriate exposure.

1.7 CA:FeX Use Case Overview

1.7.1 Use Case Overview

This section describes the Use Cases for the FHIR Health Information Exchange (HIE) Implementation Pattern, including all design constraints and assumptions as well as the flows of information that will be specified in the CA:FeX Interoperability Specifications. This section also introduces the scenarios that describe how the specified workflows may be used in the Canadian e-health context.

1.7.2 In-Scope

The following Use Cases are in scope for this release:

- UC-01 Create and Submit Document
- UC-02 Query and Retrieve Document
- UC-03 Create and Submit Data
- UC-04 Query and Retrieve Data
- UC-05 Fetch Document References

Use Case details can be found in the [Use Cases and Definitions](#) section.

1.7.3 Use Case Actors and Services

The Use Case Actors that are used by this specification are described below. Additional information can be found in the [Core Interoperability Specifications Requirements](#) section.

Use Case Actors and Descriptions

Actor Name	Description / Definition
Data Source	A health records system (e.g., EMR, HIS, CIS, PHR, or EHR) that creates/produces clinical information (e.g., fine-grained data or documentation) in response to a request from an authorized health care provider, the subject of care or another authorized health records system.

Actor Name	Description / Definition
Data Recipient	A health records system (e.g., EMR, HIS, CIS, PHR, Patient Portal, or EHR) or Clinical Data Repository that receives clinical information (e.g., fine-grained data or documentation) in response to a submission from an authorized health care provider, the subject of care or another authorized health records system.
Data Consumer	A health records system (e.g., EMR, HIS, CIS, PHR, Patient Portal or EHR) or application that requests for clinical information (e.g., fine-grained data or documentation) and enables access to or receipt by an authorized health care provider or the subject of care/patient.
Data Responder	A health records system (e.g., EMR, HIS, CIS, PHR, Patient Portal, or EHR) or Clinical Data Repository that responds to requests for clinical information (e.g., fine-grained data or documentation) from an authorized health care provider, the subject of care or another authorized health records system.

Use Case Actor Mapping

Actor Name	UC-01	UC-02	UC-03	UC-04	UC-05
Data Source	x		x		
Data Recipient	x		x		
Data Consumer		x		x	x
Data Responder		x		x	x

1.8 Core Interoperability Specification Requirements

1.8.1 Actor Mapping to Interoperability Specification

The Use Case Actors and the Services they support are described at a functional level in the [Use Cases and Definitions](#) section of the CA:FeX Interoperability Specifications. Services may be Required or Optional. The Use Case Actor, Service(s) and optionality are conveyed in the first three columns of the tables in the section below. The second part of the table (columns 4-7) provides the mapping for the Use Case Actor to the detailed specifications (such as Technical Actors and Optionality) that systems shall implement to exchange healthcare information in the context of these use cases. The purpose of the tables below is to map the use case actors to the technical actors and the services they are supporting. These tables are aligned with the flow captured in the sequence diagrams which are included in the [Sequence Diagram](#) section.

For a selected Use Case Actor (a single row in the table), the system shall implement all of the requirements (some optionality when allowed) listed in the second part of the table (columns 4-7). This includes the referenced healthcare profiles, the standards specified and terminology standards. For Technical Actors, which map to CA:FeX or an IHE Profile (*CA:FeX, PDQm, PMIR, etc.*), the last column provides the reference location of the specification. Links for these referenced specifications have been included in the tables below. Additionally, the below table does not showcase all of the possible combinations of IHE profiles and transactions that can be used for a particular implementation pattern. For example, 'Identify Patient' service can use PIXm in place of PDQm if the preferred implementation pattern is PIXm/PMIR.

Note: Patient Identifier is used below to generically describe identification of the patient. Examples of Patient Identifier are patient.id and patient.identifier.

Versioning

This is an evolving specification; the release cycle assumes some degree of change will happen across versions. (Read more about the versioning protocol [here](#).) There will be a process in place to monitor changes in the current versions of the IHE profiles which will be incorporated in future versions of the CA:FeX Interoperability Specifications based on our interoperability roadmap.

Published Versions

The following describes the published versions in scope for the required and optional IHE Profiles that have been referenced in this specification. Refer to the Reference Architecture [RA v0.1.1 DFT](#) for details:

- [IUA](#): Revision 2.1 - Trial Implementation
- [PDQm](#): v2.3.0: Trial Implementation based on FHIR R4
- [PMIR](#): Revision 1.3 – Trial Implementation

Legend

R = Required

O = Optional

1.8.2 Table 1 Interoperability Conformance Requirements for Use Case 1: Create and Submit Document

USE CASE 1: Create and Submit Document			MAPPING TO SECTIONS FROM THIS AND REFERENCED INTEROPERABILITY SPECIFICATIONS			
USE CASE ACTOR	SERVICE SUPPORTED	OPT	TECHNICAL ACTOR	OPT	PROFILE/ STANDARD	REFERENCED SPECIFICATION AND STANDARDS
Producer	Authenticate User	O	Client (e.g. EMR)	O	Internet User Authorization (IUA)	Refer to the Cross Profile Considerations section: Internet User Authorization (IUA) Grouping .

USE CASE 1: Create and Submit Document			MAPPING TO SECTIONS FROM THIS AND REFERENCED INTEROPERABILITY SPECIFICATIONS			
USE CASE ACTOR	SERVICE SUPPORTED	OPT	TECHNICAL ACTOR	OPT	PROFILE/ STANDARD	REFERENCED SPECIFICATION AND STANDARDS
	Identify Patient	O	Client (e.g. EMR)	O	Use Existing Standards Employed by the Clinical System	N/A
		O	Patient Demographic Consumer	O	PDQm	Refer to PDQm within the RA v0.1.1 DFT.
	Retrieve Clinical Data (Patient Identifier)	R	Client (e.g. EMR)	R	Use Existing Standards Employed by the Clinical System	N/A
	Assemble and Review Document	R	Client (e.g. EMR)	R	Use Existing Standards Employed by the Clinical System	N/A
	Omit or Mask Data based on Jurisdictional Policy	O	Client (e.g. EMR)	O	Jurisdictional Requirement	N/A
	Save Document to Clinical Data Repository	R	Client (e.g. EMR)	R	Use Existing Standards Employed by the Clinical System	N/A
R		Data Source	R	CA:FeX	Refer to CA:FeX 1: Submit a Document section in the CA:FeX FHIR Implementation Guide.	

USE CASE 1: Create and Submit Document			MAPPING TO SECTIONS FROM THIS AND REFERENCED INTEROPERABILITY SPECIFICATIONS			
USE CASE ACTOR	SERVICE SUPPORTED	OPT	TECHNICAL ACTOR	OPT	PROFILE/ STANDARD	REFERENCED SPECIFICATION AND STANDARDS
Recipient	Save Bundle to Clinical Data Repository	R	Data Recipient	R	CA:FeX	Refer to CA:FeX 1: Submit a Document section in the CA:FeX FHIR Implementation Guide.
Central Infrastructure	Identify Patient	O	Patient Identity Registry	O	PMIR	Refer to PMIR within the RA v0.1.1 DFT.

1.8.3 Table 2 Interoperability Conformance Requirements for Use Case 2: Query and Retrieve Document

USE CASE 2: Query and Retrieve Document			MAPPING TO SECTIONS FROM THIS AND REFERENCED INTEROPERABILITY SPECIFICATIONS			
USE CASE ACTOR	SERVICE SUPPORTED	OPT	TECHNICAL ACTOR	OPT	PROFILE/ STANDARD	REFERENCED SPECIFICATION AND STANDARDS
Consumer	Authenticate User	O	Client (e.g. EMR)	O	Internet User Authorization (IUA)	Refer to the Cross Profile Considerations section: Internet User Authorization (IUA) Grouping .
	Identify Patient	O	Client (e.g. EMR)	O	Use Existing Standards Employed by the Clinical System	N/A
		O	Patient Demographic Consumer	O	PDQm	Refer to PDQm within the RA v0.1.1 DFT.

USE CASE 2: Query and Retrieve Document			MAPPING TO SECTIONS FROM THIS AND REFERENCED INTEROPERABILITY SPECIFICATIONS			
USE CASE ACTOR	SERVICE SUPPORTED	OPT	TECHNICAL ACTOR	OPT	PROFILE/ STANDARD	REFERENCED SPECIFICATION AND STANDARDS
	Request Search Document (Patient Identifier)	R	Client (e.g. EMR)	R	Use Existing Standards Employed by the Clinical System	N/A
	Request Document (Resource ID)	R	Client (e.g. EMR)	R	Use Existing Standards Employed by the Clinical System	N/A
	Return <i>searchset</i> Bundle	R	Data Consumer	R	CA:FeX	Refer to CA:FeX 2: Search For a Document section in the CA:FeX FHIR Implementation Guide.
	Return <i>document</i> Bundle	R	Data Consumer	R	CA:FeX	Refer to CA:FeX 3: Retrieve a Document section in the CA:FeX FHIR Implementation Guide.
Responder	Retrieve Resources from Clinical Data Repository	R	Data Responder	R	CA:FeX	Refer to CA:FeX 2: Search For a Document section in the CA:FeX FHIR Implementation Guide.
	Retrieve Bundle from Clinical Data Repository	R	Data Responder	R	CA:FeX	Refer to CA:FeX 3: Retrieve a Document section in the CA:FeX FHIR Implementation Guide.
Central Infrastructure	Identify Patient	O	Patient Identity Registry	O	PMIR	Refer to PMIR within the RA v0.1.1 DFT.

1.8.4 Table 3 Interoperability Conformance Requirements for Use Case 3: Create and Submit Data

USE CASE 3: Create and Submit Data			MAPPING TO SECTIONS FROM THIS AND REFERENCED INTEROPERABILITY SPECIFICATIONS			
USE CASE ACTOR	SERVICE SUPPORTED	OPT	TECHNICAL ACTOR	OPT	PROFILE/ STANDARD	REFERENCED SPECIFICATION AND STANDARDS
Producer	Authenticate User	O	Client (e.g. EMR)	O	Internet User Authorization (IUA)	Refer to the Cross Profile Considerations section: Internet User Authorization (IUA) Grouping .
	Identify Patient	O	Client (e.g. EMR)	O	Use Existing Standards Employed by the Clinical System	N/A
		O	Patient Demographic Consumer	O	PDQm	Refer to PDQm within the RA v0.1.1 DFT.
	Retrieve Clinical Data (Patient Identifier)	R	Client (e.g. EMR)	R	Use Existing Standards Employed by the Clinical System	N/A
	Assemble and Review Data	O	Client (e.g. EMR)	O	Use Existing Standards Employed by the Clinical System	N/A
	Omit or Mask Data based on Jurisdictional Policy	O	Client (e.g. EMR)	O	Jurisdictional Requirement	N/A

USE CASE 3: Create and Submit Data			MAPPING TO SECTIONS FROM THIS AND REFERENCED INTEROPERABILITY SPECIFICATIONS			
USE CASE ACTOR	SERVICE SUPPORTED	OPT	TECHNICAL ACTOR	OPT	PROFILE/ STANDARD	REFERENCED SPECIFICATION AND STANDARDS
	Save Data to Clinical Data Repository	R	Client (e.g. EMR)	R	Use Existing Standards Employed by the Clinical System	N/A
		R	Data Source	R	CA:FeX	Refer to the Submit Data section in the CA:FeX FHIR Implementation Guide.
Recipient	Save Data to Clinical Data Repository	R	Data Recipient	R	CA:FeX	Refer to the Submit Data section in the CA:FeX FHIR Implementation Guide.
Central Infrastructure	Identify Patient	O	Patient Identity Registry	O	PMIR	Refer to PMIR within the RA v0.1.1 DFT.

1.8.5 Table 4 Interoperability Conformance Requirements for Use Case 4: Query and Retrieve Data

USE CASE 4: Query and Retrieve Data			MAPPING TO SECTIONS FROM THIS AND REFERENCED INTEROPERABILITY SPECIFICATIONS			
USE CASE ACTOR	SERVICE SUPPORTED	OPT	TECHNICAL ACTOR	OPT	PROFILE/ STANDARD	REFERENCED SPECIFICATION AND STANDARDS
Consumer	Authenticate User	O	Client (e.g. EMR)	O	Internet User Authorization (IUA)	Refer to the Cross Profile Considerations section: Internet User Authorization (IUA) Grouping .

USE CASE 4: Query and Retrieve Data			MAPPING TO SECTIONS FROM THIS AND REFERENCED INTEROPERABILITY SPECIFICATIONS			
USE CASE ACTOR	SERVICE SUPPORTED	OPT	TECHNICAL ACTOR	OPT	PROFILE/ STANDARD	REFERENCED SPECIFICATION AND STANDARDS
	Identify Patient	O	Client (e.g. EMR)	O	Use Existing Standards Employed by the Clinical System	N/A
		O	Patient Demographic Consumer	O	PDQm	Refer to PDQm within the RA v0.1.1 DFT.
	Request Query and Retrieve (Patient Identifier)	R	Client (e.g. EMR)	R	Use Existing Standards Employed by the Clinical System	N/A
	Return Data Bundle	R	Data Consumer	R	CA:FeX	Refer to the Search For Data section in the CA:FeX FHIR Implementation Guide as well as the Response Handling page.
Responder	Return Data Bundle	R	Data Responder	R	CA:FeX	Refer to the Search For Data section in the CA:FeX FHIR Implementation Guide.
Central Infrastructure	Identify Patient	O	Patient Identity Registry	O	PMIR	Refer to PMIR within the RA v0.1.1 DFT.

1.8.6 Table 5 Interoperability Conformance Requirements for Use Case 5: Fetch Document References

USE CASE 5: Fetch Document References			MAPPING TO SECTIONS FROM THIS AND REFERENCED INTEROPERABILITY SPECIFICATIONS			
USE CASE ACTOR	SERVICE SUPPORTED	OPT	TECHNICAL ACTOR	OPT	PROFILE/ STANDARD	REFERENCED SPECIFICATION AND STANDARDS
Consumer	Authenticate User	O	Client (e.g. EMR)	O	Internet User Authorization (IUA)	Refer to the Cross Profile Considerations section: Internet User Authorization (IUA) Grouping .
	Identify Patient	O	Client (e.g. EMR)	O	Use Existing Standards Employed by the Clinical System	N/A
		O	Patient Demographic Consumer	O	PDQm	Refer to PDQm within the RA v0.1.1 DFT.
	Request Clinical Document References (Patient Identifier/ operation params)	R	Client (e.g. EMR)	R	Use Existing Standards Employed by the Clinical System	N/A
	Request Clinical Document (Resource ID)	R	Client (e.g. EMR)	R	Use Existing Standards Employed by the Clinical System	N/A
	Return Clinical Document References	R	Data Consumer	R	CA:FeX	Refer to CA:FeX 2B: Generate or Retrieve a DocumentReference using \$docRef Operation section in the CA:FeX FHIR Implementation Guide.

USE CASE 5: Fetch Document References			MAPPING TO SECTIONS FROM THIS AND REFERENCED INTEROPERABILITY SPECIFICATIONS			
USE CASE ACTOR	SERVICE SUPPORTED	OPT	TECHNICAL ACTOR	OPT	PROFILE/ STANDARD	REFERENCED SPECIFICATION AND STANDARDS
	Return Clinical Document	R	Data Consumer	R	CA:FeX	Refer to CA:FeX 3A in the Retrieve a Document section in the CA:FeX FHIR Implementation Guide.
Responder	Return Clinical Document References	R	Data Responder	R	CA:FeX	Refer to CA:FeX 2B: Generate or Retrieve a DocumentReference using \$docRef Operation section in the CA:FeX FHIR Implementation Guide.
	Return Clinical Document	R	Data Responder	R	CA:FeX	Refer to CA:FeX 3A in the Retrieve a Document section in the CA:FeX FHIR Implementation Guide.
Central Infrastructure	Identify Patient	O	Patient Identity Registry	O	PMIR	Refer to PMIR within the RA v0.1.1 DFT.

1.9 Actor Conformance

A system conforming to the CA:FeX Interoperability Specifications shall claim conformance at the level of a Use Case Actor (first columns of the Tables in [Core Interoperability Specification Requirements](#)). A system may claim conformance to one or more Use Case Actors among:

- Data Source
- Data Consumer
- Data Recipient
- Data Responder

Data Source and Data Consumer use case actor roles will primarily be taken up by EMR clinical solution vendors. Data Recipient and Data Responder use case actor roles can be taken up either by EMR clinical solution vendors or jurisdictions depending on the implementation approach that the jurisdiction decides to adopt. Similarly, the Data Consumer can be a Patient Portal, in which case the use case actor can be taken up either by a vendor or jurisdiction depending on the approach and policies defined regarding patient / subject of care access to their personal health information (PHI).

In order to implement a system that fully supports the CA:FeX Interoperability Specifications, the system shall be able to demonstrate that it conforms to every required actor and transaction for which it is claiming conformance.

1.9.1 Constraints on Use Case Actors

The section below captures some of the design constraints on use case actors when developing functionality to support the services mapped to them.

Note: The scope of this section is limited to the constraints that are applicable to actors and transactions defined for CA:FeX Interoperability Specifications (See section [CA:FeX Actors and Transactions](#)). The key services supported by CA:FeX are:

- Save Document to Clinical Data Repository
- Retrieve Document from Clinical Data Repository
- Save Data to Clinical Data Repository
- Search and Retrieve Data from Clinical Data Repository
- Fetch Document References from Clinical Data Repository

The following section provides key design constraints for implementation of these two required services using RESTful APIs based on CA:FeX and FHIR standards. To support these services, the following three RESTful transactions have been defined:

Service Supported	FHIR RESTful Transactions
Save Document to Clinical Data Repository	Submit Data [CA:FeX-1]
Search and Retrieve Document from Clinical Data Repository	Search Data [CA:FeX-2]
	Retrieve Data [CA:FeX-3]
Save Data to Clinical Data Repository	Submit Data [CA:FeX-1]
Search and Retrieve Data from Clinical Data Repository	Search Data [CA:FeX-2]
	Retrieve Data [CA:FeX-3]
Fetch Document References from Clinical Data Repository	Search Data [CA:FeX-2]
	Retrieve Data [CA:FeX-3]

Save Data or Document to Clinical Data Repository

The Producer and Recipient Use Case Actors are required to implement the *Save Document to Clinical Data Repository* service or the *Save Data to Clinical Data Repository* service.

These actors shall use the FHIR transaction **Submit Data [CA:FeX-1]** of CA:FeX that executes a *Submit Data request* from a Data Source to a Data Recipient.

Submit Data [CA:FeX-1]

This message involves a request by a Data Source to transfer a FHIR resources (Documents or individual resources) to a Data Recipient. The request is received by a Data Recipient which stores the received FHIR resources and returns an HTTP response code.

Trigger Events

This method is invoked when the Data Source needs to submit one or more FHIR resources to a Data Recipient (Clinical Data Repository).

Message Semantics

This message uses the **HTTP POST** method on the target Submit Data endpoint to convey the metadata and the FHIR Resource(s) as a FHIR transaction. The Data Source shall initiate a FHIR “transaction” using a “create” action by sending an **HTTP POST** request method composed of a FHIR Resource. The media type of the HTTP body shall support application/fhir+json and should support application/fhir+xml. Additional information on this FHIR implementation pattern is provided in the [Submit a Document](#) section and the [Submit Data section](#) in the CA:FeX FHIR Implementation Guide.

Expected Actions

The Data Recipient shall accept media types application/fhir+json and application/fhir+xml. On receipt of the submission, the Data Recipient shall validate the resources and respond with one of the HTTP response codes and an [OperationOutcome](#), if applicable. Additional information on handling responses is provided in the [Response Handling](#) section of the CA:FeX FHIR Implementation Guide.

Retrieve Data or Document from Clinical Data Repository

The Consumer and Responder Use Case Actors are required to implement the *Retrieve Document from Clinical Data Repository* service or the *Retrieve Data from Clinical Data Repository* service.

These actors shall use the following transactions to find metadata and retrieval of identified clinical information:

- **Search Data [CA:FeX-2]**
- **Retrieve Data [CA:FeX-3]**

Search Data [CA:FeX-2]

This message involves a query request by a Data Consumer to find FHIR Resources using parameterized queries. The request is received by a Data Responder which returns a Bundle containing the matching search parameters.

The Data Consumer may use HTTP GET or HTTP POST based searches. The Data Responder shall support both GET and POST based searches.

Trigger Events

When a Data Consumer needs to discover a list of FHIR Resources that match search parameters.

Message Semantics

The Data Consumer executes an **HTTP search request** against the Data Responder endpoint (FHIR Repository).

The Data Consumer may use **HTTP GET** or **HTTP POST** based searches. The Data Responder shall support both GET and POST based searches.

GET [base]/[resourcetype]?name=value&...

POST [base]/[type]/_search?{[parameters]}{&_format=[mime-type]}

Query Search Parameters

Search parameter requirements can be found in the [Search Parameter](#) page and the [CapabilityStatement](#) page of the CA:FeX FHIR Implementation Guide.

Expected Actions

The Data Responder shall process the query and return a search result matching the search criteria included in the request. The FHIR standard provides encodings for responses as either XML or JSON.

Additional information on handling responses is provided in the [Response Handling](#) section of the CA:FeX FHIR Implementation Guide.

Security Considerations

Data Responder SHALL reject any unauthorized requests by returning an HTTP 401 unauthorized response code. This transaction should not return information that the Data Consumer is not authorized to access (authorization here is inclusive of system, app, and user according to local policy, patient consents, and security layering). However, the transaction may return search bundle that have Reference elements that the Data Consumer may not have access to. This is to say that the authorization need only be to the content returned in the Bundle. There may be references (URLs) for which the content is not authorized. This is considered proper as the Data Consumer would need to retrieve the content pointed to by those references, and at that time the proper authorization decision would be made on that context and content. In this way it is possible for a Data Consumer to get Resources that are pointing at data that the Data Consumer is not authorized to retrieve. Thus, the URLs used must be carefully crafted so as to not expose sensitive data in the URL value.

Retrieve Data [CA:FeX-3]

This message involves a request by a Data Consumer for retrieving a known FHIR Resource using the resource id from a Clinical Data Repository. The request is received by a Data Responder which returns the requested FHIR Resource or returns an HTTP response code.

This message uses the HTTP GET request to retrieve the identified FHIR Resource from the central Clinical Data Repository.

Trigger Events

This method is invoked when the Data Consumer needs to retrieve a FHIR Resource.

Message Semantics

The Data Consumer sends an HTTP GET request to the server based on a known resource id from the Data Responder. This operation will return a Bundle that was previously identified in a search/or prior retrieval of FHIR Resources.

GET [base]/[resourcetype]?name=value&...

Additional information on this FHIR implementation pattern is provided in the [Document Exchange Guidance](#) in the CA:FeX FHIR Implementation Guide.

Expected Actions

The Data Responder shall process the GET request and respond with a FHIR Resource that matches the specified resource id included in the request. When the requested resource is returned, the Data Responder shall respond with an HTTP Status Code 200. The HTTP message-body shall be the content of the requested resource.

Additional information on handling responses is provided in the [Response Handling](#) section of the CA:FeX FHIR Implementation Guide.

Security Considerations

Data Responder SHALL reject any unauthorized requests by returning an HTTP 401 unauthorized response code. This transaction should not return information that the Data Consumer is not authorized to access.

Fetch Document References from Clinical Data Repository

The Consumer and Responder Use Case Actors are required to implement the *Fetch Document References* service.

These actors shall use the following transactions to find the list of documents and retrieval of identified clinical documents:

- **Search Data [CA:FeX-2B]**
- **Retrieve Data [CA:FeX-3]**

Search Data [CA:FeX-2]

This message involves the execution of the FHIR [\\$docRef operation](#) by a Data Consumer to fetch FHIR Resources using Operation-defined criteria (input parameters) to narrow the clinical document references that are created and/or returned. The request is received by a Data Responder which returns a "searchset" Bundle that includes document references that match the provided input parameters.

The Data Consumer may use HTTP GET or HTTP POST based searches. The Data Responder shall support both GET and POST based searches.

Trigger Events

When a Data Consumer needs to discover a list of documents that match search parameters.

Message Semantics

The Data Consumer executes the \$docRef operation against the Data Responder endpoint (FHIR Repository).

The Data Consumer uses **HTTP GET** to execute the operation.

GET [base]/DocumentReference/\$docref?patient=[id]

Query Search Parameters

Input parameter requirements can be found in the [Operations](#) page of the CA:FeX FHIR Implementation Guide.

Expected Actions

The Data Responder shall execute the operation and return a "searchset" Bundle that includes document references that match the provided input parameters. The FHIR standard provides encodings for responses as either XML or JSON.

Additional information on handling responses is provided in the [Response Handling](#) section of the CA:FeX FHIR Implementation Guide.

Security Considerations

Data Responder SHALL reject any unauthorized requests by returning an HTTP 401 unauthorized response code. This transaction should not return information that the Data Consumer is not authorized to access (authorization here is inclusive of system, app, and user according to local policy, patient consents, and security layering). However, the transaction may return search bundle that have Reference elements that the Data Consumer may not have access to. This is to say that the authorization need only be to the content returned in the Bundle. There may be references (URLs) for which the content is not authorized. This is considered proper as the Data Consumer would need to retrieve the content pointed to by those references, and at that time the proper authorization decision would be made on that context and content. In this way it is possible for a Data Consumer to get Resources that are

pointing at data that the Data Consumer is not authorized to retrieve. Thus, the URLs used must be carefully crafted so as to not expose sensitive data in the URL value.

1.10 CA:FeX Actors and Transactions

The following diagram illustrates the actors and transactions in scope for the CA:FeX Interoperability Specification.

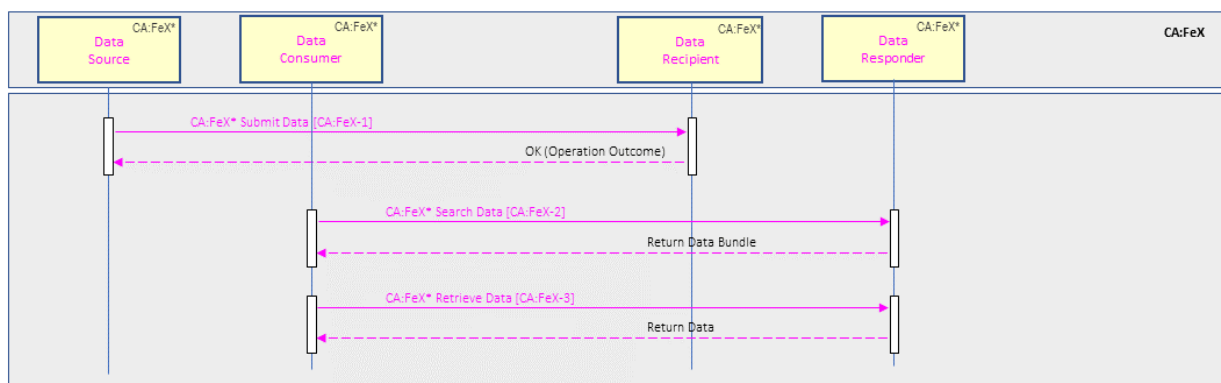

There are three primary transactions for the CA:FeX Interoperability Specification, along with additional transaction specializations listed below for specific circumstances. Please refer to the [Exchanging Data & Documents in FHIR section](#) for more details.

Transaction ID	Transaction Description	Additional Details (Transaction Specializations):
CA:FeX-1	Submit Data	N/A
CA:FeX-2	Search Data	CA:FeX-2A: Search Against FHIR Assembled Documents Repository
		CA:FeX-2B: Search Against Hybrid Documents Repository
CA:FeX-3	Retrieve Data	CA:FeX-3A: Retrieve Document From FHIR Assembled Documents Repository
		CA:FeX-3B: Retrieve Document from Hybrid Documents Repository

1.11 CA:FeX Sequence Diagrams

The CA:FeX sequence diagrams provide guidance on how to apply CA:FeX implementation patterns along with other IHE profiles to address interoperability needs pertaining to FHIR Health Information Exchange (HIE) implementation patterns. They group together actors and transactions from multiple profiles including CA:FeX to address the scope of the use cases.

1.11.1 Sequence Diagram for UC-01: Create and Submit Document

Scenario: Clinical Solution Submits a Document to a Central Clinical Data Repository.

Assumption: Document is stored in a Clinical Data Repository.

This sequence diagram provides the option of using the CA:FeX Interoperability Specifications that provide support for submitting documents to a central Clinical Data Repository. This specification includes a Data Source and a Data Recipient actor. Additionally, this sequence diagram uses the 'Submit Data' FHIR operation.

Sequence Diagram Overview:

Below provides guidance on how to read the sequence diagram:

- This sequence diagram illustrates how the different standardized actors of a system should interact with each other to carry out specific standardized transactions, and the order in which the transactions and interactions occur when [UC-01 Create and Submit Document](#) of the CA:FeX Specification is executed.
- The legend on the bottom right corner describes the different system components, actors and transactions that are necessary to carry out this use case.
- The green swim lane is a simplified view of the actors and transactions required by the Foundational Profiles, defined [here](#), in addition to the other ones that are not explicitly illustrated on the diagram (e.g., ATNA, CT, etc.) but included as a white note. These are pre-requisite conditions for this use case and it is assumed that these will be satisfied.
- The blue swim lanes group a sequence of processes (along with their required actors and transactions) that are needed to occur to satisfy this use case. These are to be read from left to right and top to bottom.
- The red note boxes describe important information and notes that provide more context for the sequence diagram.
- For more information on core IHE Profiles and specific Canadian implementation guidance, refer to the Reference Architecture available here: [RA v0.1.1 DFT](#).

Additional Considerations

The sequence diagrams included in this section do not showcase all of the possible combinations of IHE profiles and transactions that can be used for a particular implementation pattern. For example, ITI-83 transaction can be used in place of ITI-78 if the preferred implementation pattern is PIXm/PMIR.

UC-01: Create and Submit Document – CA:FeX

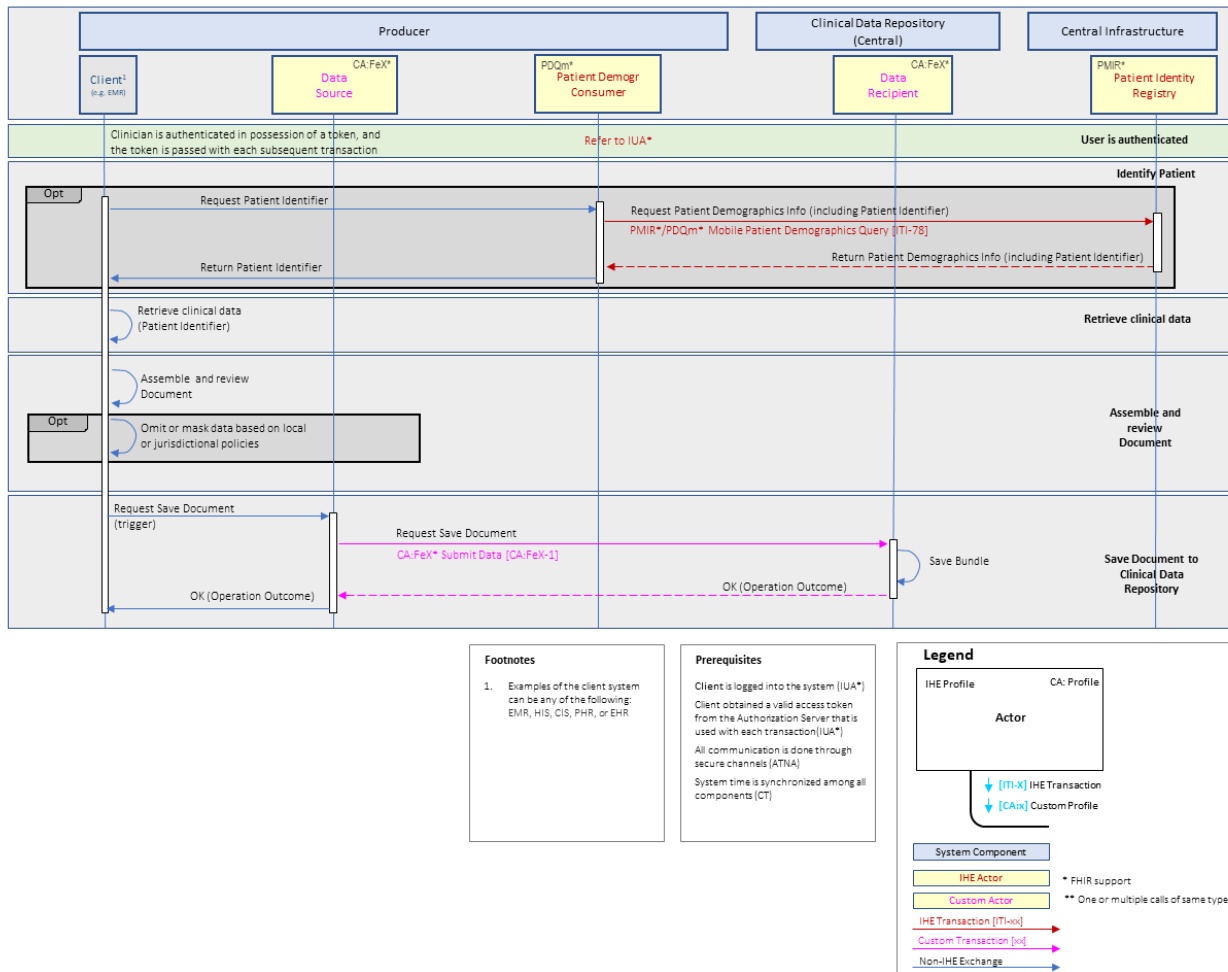

1.11.2 Sequence Diagram for UC-02: Query and Retrieve Document

Scenario: Clinical Solution Queries and Retrieves Document(s) from a Clinical Data Repository.

Assumption: Document(s) are stored in a Central Clinical Data Repository.

This sequence diagram provides the option of using the CA:FeX Interoperability Specifications that provide support for retrieving data document(s) from a central Clinical Data Repository. This specification includes a Data Consumer and a Data Responder actor. Additionally, this sequence diagram uses the 'Search Data' and 'Retrieve Data' FHIR operations.

Sequence Diagram Overview:

Below provides guidance on how to read the sequence diagram:

- This sequence diagram illustrates how the different standardized actors of a system should interact with each other to carry out specific standardized transactions, and the order in which the transactions and interactions occur when **UC-02 Query and Retrieve Document** of the CA:FeX Specification is executed.
- Data Consumer role varies by client type:
 - HCP: Clinical Solution, e.g., EMR used by the Health Care Provider to request & retrieve access to clinical document(s) from the Clinical Data Repository

- Patient: Patient Portal used by the Patient / Subject of Care to request & retrieve access to their clinical document(s) from the Clinical Data Repository
- The legend on the bottom right corner describes the different system components, actors and transactions that are necessary to carry out this particular use case.
- The green swim lane is a simplified view of the actors and transactions required by the Foundational Profiles, defined [here](#), in addition to the other ones that are not explicitly illustrated on the diagram (e.g. ATNA, CT) but included as a white note. These are pre-requisite conditions for this particular use case and it is assumed that these will be satisfied.
- The blue swim lanes group sequence of processes (along with their required actors and transactions) that are needed to occur to satisfy this particular use case. These are to be read from left to right and top to bottom.
- The red note boxes describe important call outs, information and notes that provide more context for the sequence diagram.
- For more information on core IHE Profiles and specific Canadian implementation guidance, refer to the Reference Architecture available here: [RA v0.1.1 DFT](#).

Additional Considerations

The sequence diagrams included in this section do not showcase all of the possible combinations of IHE profiles and transactions that can be used for a particular implementation pattern. For example, ITI-83 transaction can be used in place of ITI-78 if the preferred implementation pattern is PIXm/PMIR.

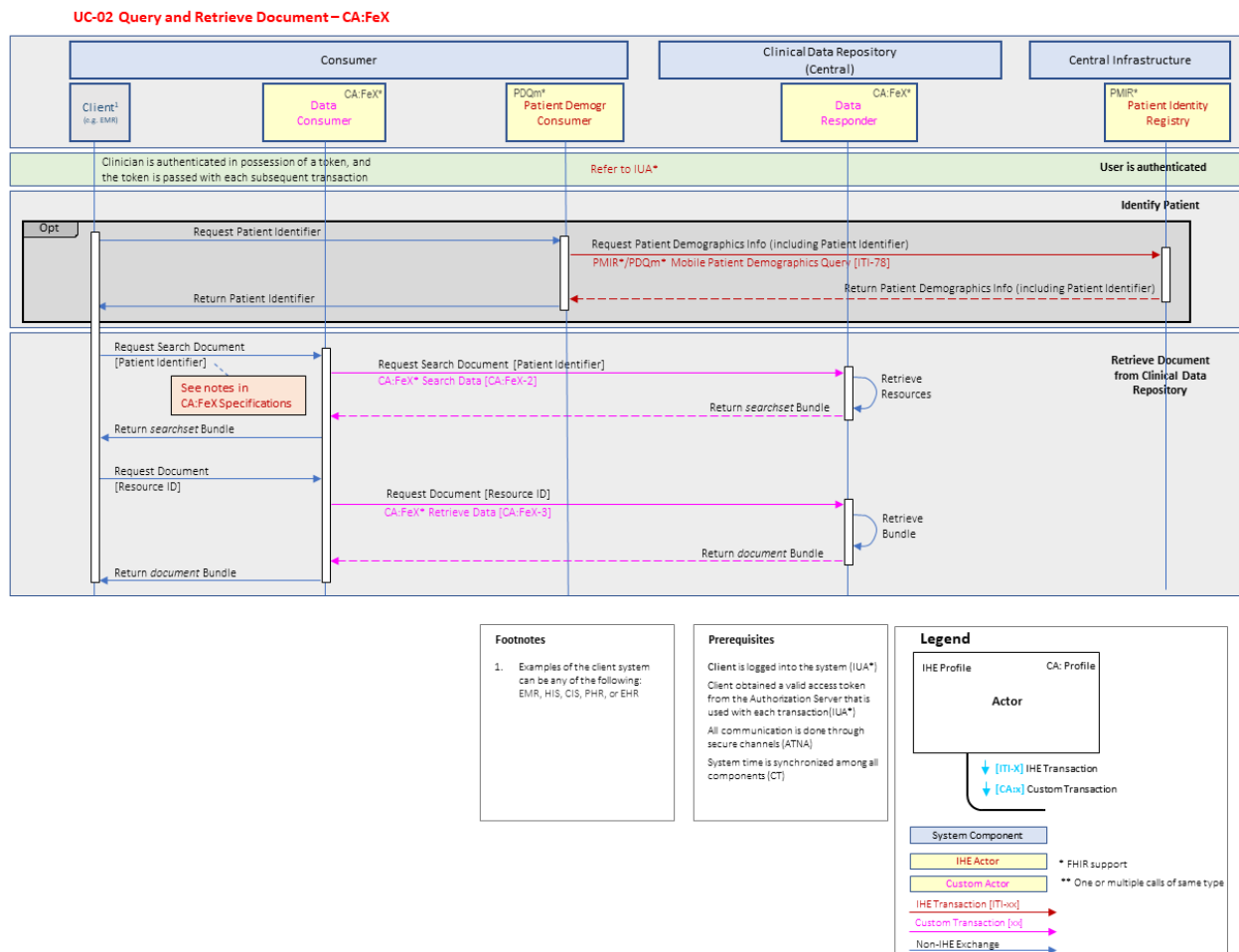

1.11.3 Sequence Diagram for UC-03: Create and Submit Data

Scenario: Clinical Solution Submits Clinical Data to a Central Clinical Data Repository.

Assumption: Clinical Information (FHIR Resource) is stored in a Clinical Data Repository.

This sequence diagram provides the option of using the CA:FeX Interoperability Specifications that provide support for submitting data (e.g., Single FHIR Resources) to a central Clinical Data Repository. This specification includes a Data Source and a Data Recipient actor. Additionally, this sequence diagram uses the 'Submit Data' transaction.

Sequence Diagram Overview:

Below provides guidance on how to read the sequence diagram:

- This sequence diagram illustrates how the different standardized actors of a system should interact with each other to carry out specific standardized transactions, and the order in which the transactions and interactions occur when [UC-03 Create and Submit Data](#) of the CA:FeX Specification is executed.
- The legend on the bottom right corner describes the different system components, actors and transactions that are necessary to carry out this use case.
- The green swim lane is a simplified view of the actors and transactions required by the Foundational Profiles, defined [here](#), in addition to the other ones that are not explicitly illustrated on the diagram (e.g., ATNA, CT, etc.) but included as a white note. These are pre-requisite conditions for this use case and it is assumed that these will be satisfied.
- The blue swim lanes group a sequence of processes (along with their required actors and transactions) that are needed to occur to satisfy this use case. These are to be read from left to right and top to bottom.
- The red note boxes describe important information and notes that provide more context for the sequence diagram.
- For more information on core IHE Profiles and specific Canadian implementation guidance, refer to the Reference Architecture available here: [RA v0.1.1 DFT](#).

Additional Considerations

The sequence diagrams included in this section do not showcase all of the possible combinations of IHE profiles and transactions that can be used for a particular implementation pattern. For example, ITI-83 transaction can be used in place of ITI-78 if the preferred implementation pattern is PIXm/PMIR.

UC-03: Create and Submit Data – CA:FeX

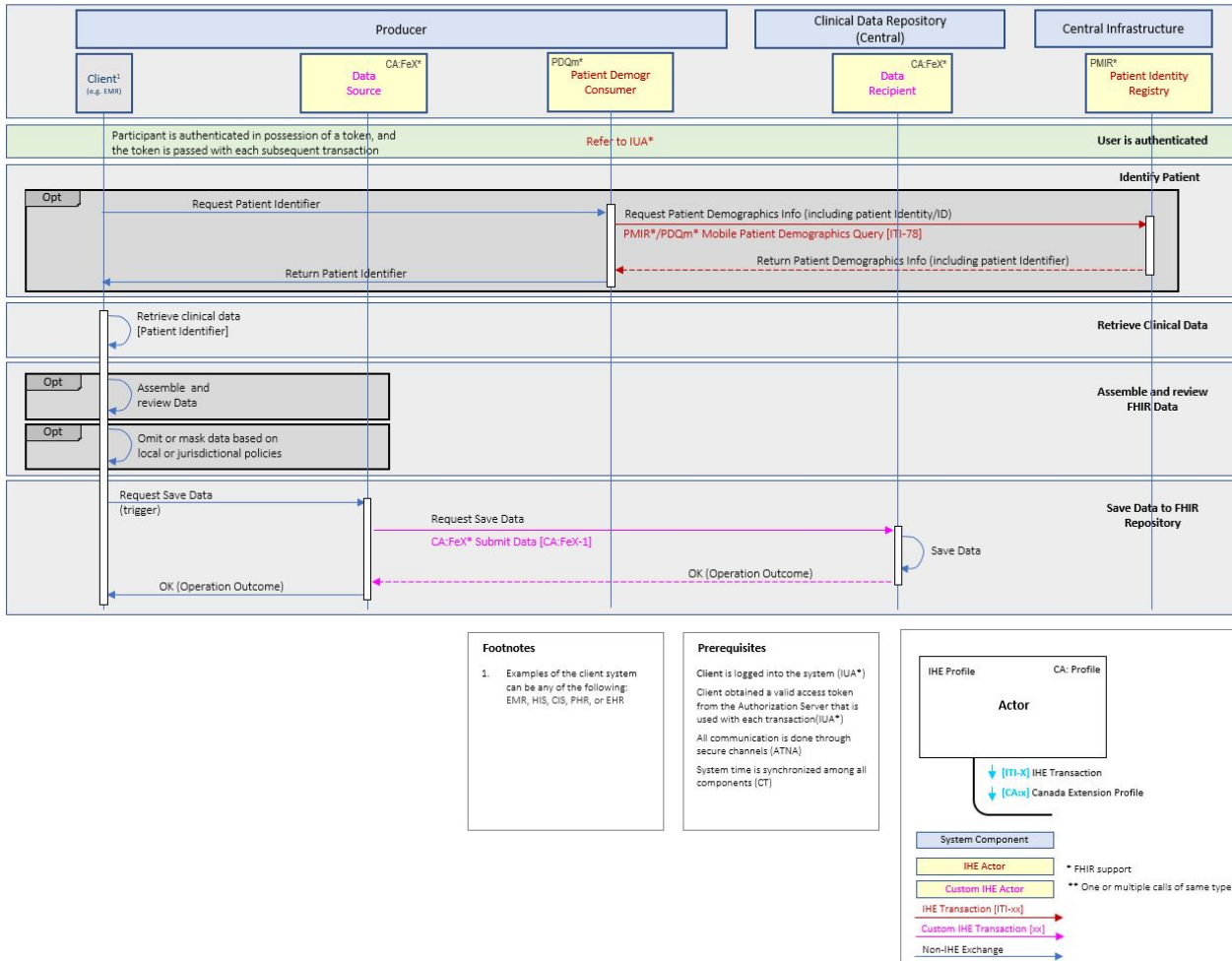

1.11.4 Sequence Diagram for UC-04: Query and Retrieve Data

Scenario: Clinical Solution Queries and Retrieves Clinical Data from a Clinical Data Repository.

Assumption: Clinical Data is stored in a Central Clinical Data Repository

This sequence diagram provides the option of using the CA:FeX Interoperability Specifications that provide support for retrieving data (e.g. Single FHIR Resources) from a central Clinical Data Repository. This specification includes a Data Consumer and a Data Responder actor. Additionally, this sequence diagram uses the 'Search Data' and 'Retrieve Data' transactions.

Sequence Diagram Overview:

Below provides guidance on how to read the sequence diagram:

- This sequence diagram illustrates how the different standardized actors of a system should interact with each other to carry out specific standardized transactions, and the order in which the transactions and interactions occur when **UC-04 Query and Retrieve Data** of the CA:FeX Specification is executed.
- Data Consumer role varies by client type:
 - HCP: Clinical Solution, e.g., EMR used by the Health Care Provider to request & retrieve access to clinical information from the Clinical Data Repository

- Patient: Patient Portal used by the Patient / Subject of Care to request & retrieve access to their clinical information from the Clinical Data Repository
- The legend on the bottom right corner describes the different system components, actors and transactions that are necessary to carry out this particular use case.
- The green swim lane is a simplified view of the actors and transactions required by the Foundational Profiles, defined [here](#), in addition to the other ones that are not explicitly illustrated on the diagram (e.g. ATNA, CT) but included as a white note. These are pre-requisite conditions for this particular use case and it is assumed that these will be satisfied.
- The blue swim lanes group sequence of processes (along with their required actors and transactions) that are needed to occur to satisfy this particular use case. These are to be read from left to right and top to bottom.
- The red note boxes describe important call outs, information and notes that provide more context for the sequence diagram.
- For more information on core IHE Profiles and specific Canadian implementation guidance, refer to the Reference Architecture available here: [RA v0.1.1 DFT](#).

Additional Considerations

The sequence diagrams included in this section do not showcase all of the possible combinations of IHE profiles and transactions that can be used for a particular implementation pattern. For example, ITI-83 transaction can be used in place of ITI-78 if the preferred implementation pattern is PIXm/PMIR.

UC-04: Query and Retrieve Data – CA:FeX

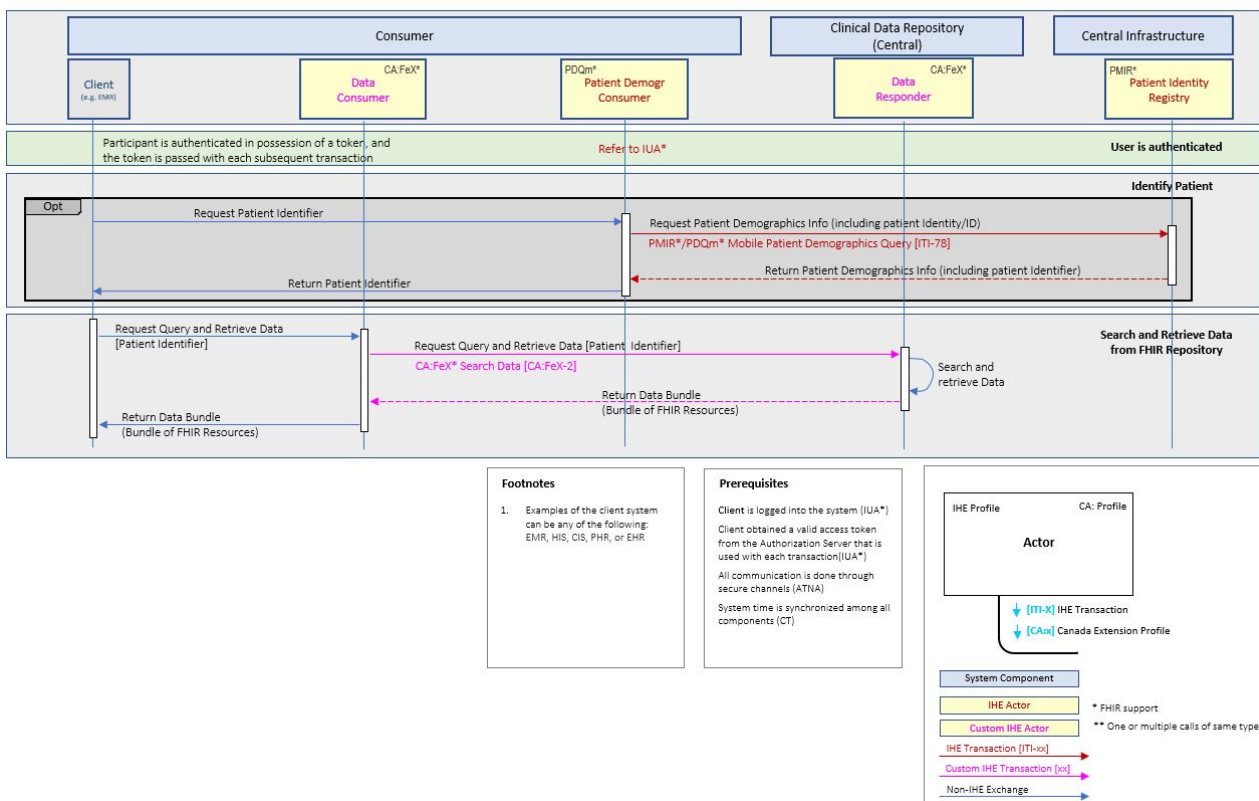

1.11.5 Sequence Diagram for UC-05: Fetch Document References

Scenario: Clinical Solution Fetches Document References from a Clinical Data Repository.

Assumption: References to document(s) are stored in a Central Clinical Data Repository.

This sequence diagram provides the option of using the CA:FeX Interoperability Specifications that provide support for fetching document references from a central Clinical Data Repository. This specification includes a Data Consumer and a Data Responder actor. Additionally, this sequence diagram uses the 'Search Data' and 'Retrieve Data' transactions.

Sequence Diagram Overview:

Below provides guidance on how to read the sequence diagram:

- This sequence diagram illustrates how the different standardized actors of a system should interact with each other to carry out specific standardized transactions, and the order in which the transactions and interactions occur when [UC-05 Fetch Document References](#) of the CA:FeX Specification is executed.
- Data Consumer role varies by client type:
 - HCP: Clinical Solution, e.g., EMR used by the Health Care Provider to request & retrieve access to clinical information from the Clinical Data Repository
 - Patient: Patient Portal used by the Patient / Subject of Care to request & retrieve access to their clinical information from the Clinical Data Repository
- The legend on the bottom right corner describes the different system components, actors and transactions that are necessary to carry out this particular use case.
- The green swim lane is a simplified view of the actors and transactions required by the Foundational Profiles, defined [here](#), in addition to the other ones that are not explicitly illustrated on the diagram (e.g. ATNA, CT) but included as a white note. These are pre-requisite conditions for this particular use case and it is assumed that these will be satisfied.
- The blue swim lanes group sequence of processes (along with their required actors and transactions) that are needed to occur to satisfy this particular use case. These are to be read from left to right and top to bottom.
- The red note boxes describe important call outs, information and notes that provide more context for the sequence diagram.
- For more information on core IHE Profiles and specific Canadian implementation guidance, refer to the Reference Architecture available here: [RA v0.1.1 DFT](#).

Additional Considerations

The sequence diagrams included in this section do not showcase all of the possible combinations of IHE profiles and transactions that can be used for a particular implementation pattern. For example, ITI-83 transaction can be used in place of ITI-78 if the preferred implementation pattern is PIXm/PMIR.

UC-05: Fetch Document References – CA:FeX

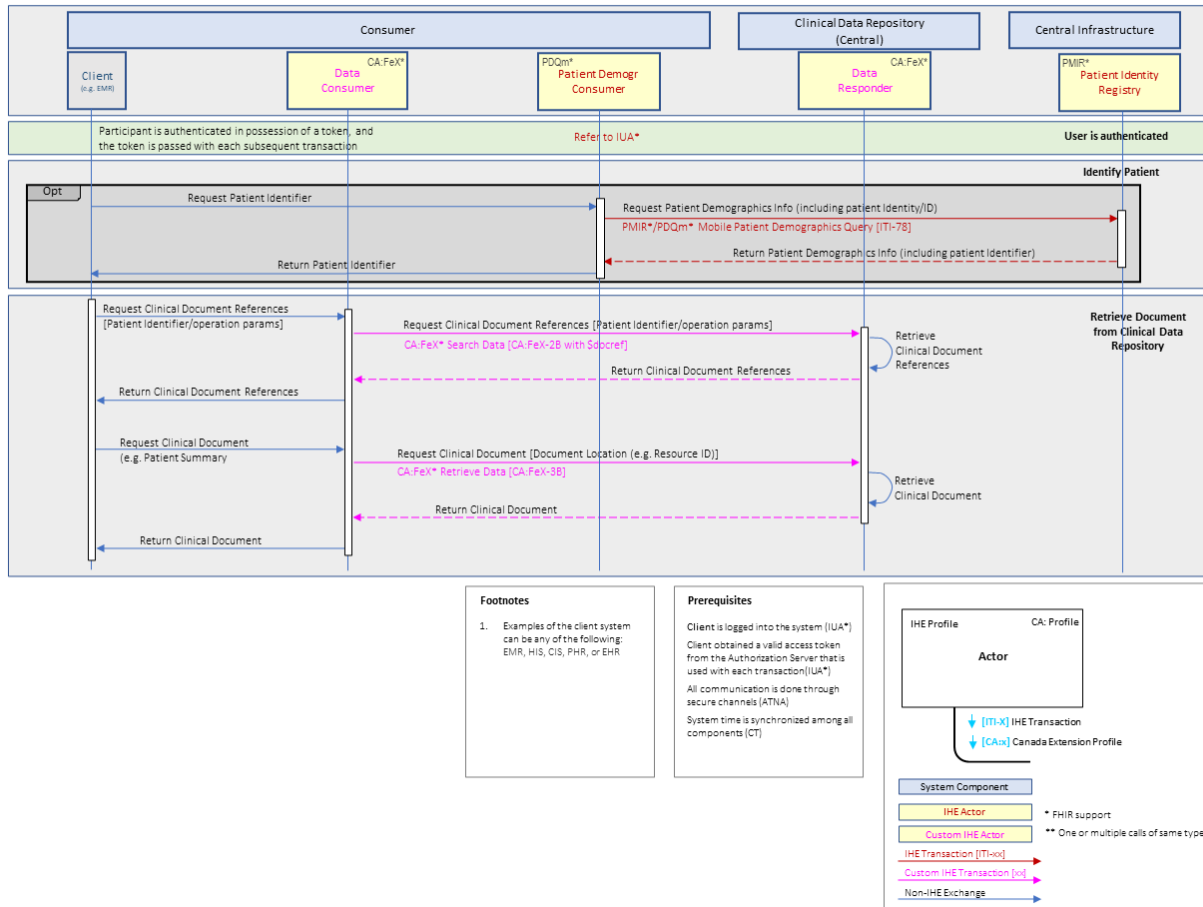

1.12 CA:FeX Cross Profile Considerations

This section provides guidance on groupings between the CA:FeX actors with other IHE profiles to achieve additional functionality such as Network Security, Authentication, Authorization, Auditing and more.

1.12.1 Consistent Time (CT) Grouping

The **Consistent Time (CT)** Profile provides a means to ensure that the system clocks and time stamps of the computers in a network are synchronized. To allow for these features, CA:FeX actors can be grouped with CT actors.

For the specific Canadian implementation guidance for the CT profile, refer to the RA v0.1.1 DFT, section [CT - Canadian Implementation Guidance](#).

If the grouping is in place, an actor from CA:FeX shall implement the required transactions and/or content modules in CA:FeX in addition to all the transactions required for the grouped actor (Column 2).

CA:FeX Actor	Actor(s) to be grouped with
Data Source	CT / Time Client

Data Recipient	CT / Time Client
Data Consumer	CT / Time Client
Data Responder	CT / Time Client

1.12.2 Internet User Authorization (IUA) Grouping

The [Internet User Authorization \(IUA\)](#) Profile provides support for user authentication, app authentication, and authorization decisions. To allow for these features, CA:FeX actors can be grouped with IUA actors.

For the specific Canadian implementation guidance for the IUA profile, refer to the RA v0.1.1 DFT, section [IUA - Canadian Implementation Guidance](#).

If the grouping is in place, an actor from CA:FeX shall implement the required transactions and/or content modules in CA:FeX **in addition to all** the transactions required for the grouped actor (Column 2).

CA:FeX Actor	Actor(s) to be grouped with
Data Source	IUA / Authorization Client
Data Recipient	IUA / Resource Server
Data Consumer	IUA / Authorization Client
Data Responder	IUA / Resource Server

The CA:FeX Data Source and Data Consumer actors, when grouped with IUA Authorization Client, shall use Get Access Token [ITI-71] to request the corresponding scope from the IUA Authorization Server.

This enables the CA:FeX actor to submit the corresponding CA:FeX transaction with the combined transaction Incorporate Access Token [ITI-72].

The CA:FeX Data Recipient and Data Responder actors. When grouped with IUA Resource Server, shall require Incorporate Access Token [ITI-72] in all CA:FeX transaction requests, shall enforce the authorization decision in the token, and may further enforce policies beyond those made by the Authorization Server such as consent or business rules.

There are additional security and privacy functionalities enabled by this grouping.

- Transactions are combined with IUA transactions requiring access tokens
- There are additional requirements and functionality enabled through scope definitions that are transaction specific.

Actors	Transactions	IUA/OIDC Scopes
Data Source	Submit Data [CA:FeX-1]	CAFEX-1
Data Recipient	Submit Data [CA:FeX-1]	CAFEX-1

Data Consumer	Search Data [CA:FeX-2]	CAFEX-2
	Retrieve Data [CA:FeX-3]	CAFEX-3
Data Responder	Search Data [CA:FeX-2]	CAFEX-2
	Retrieve Data [CA:FeX-3]	CAFEX-3

Each scope authorizes the full CA:FeX transaction. This scope implicitly allows for patient-specific CRUD/S operations in line with and supported by the corresponding CA:FeX transaction.

Further scope refinement is allowed in realm or project-specific situations; these scopes would be in addition to the scopes defined here.

1.12.3 Canadian Network Security (CA:Sec) Grouping

The Reference Architecture provides specific Canadian implementation guidance for the implementation of the network security aspect of the ATNA profile in Canada. For details, refer to the RA v0.1.1 DFT, section [Canadian Network Security \(CA:Sec\) Implementation Guidance](#).

CA:Sec provides support for secure network communication. To allow for these features, CA:FeX actors can be grouped with CA:Sec actors.

If the grouping is in place, an actor from CA:FeX shall implement the required transactions and/or content modules in CA:FeX **in addition to all** the transactions required for the grouped actor (Column 2).

CA:FeX Actor	Actor(s) to be grouped with
Data Source	CA:Sec / Secure Application
Data Recipient	CA:Sec / Secure Application
Data Consumer	CA:Sec / Secure Application
Data Responder	CA:Sec / Secure Application

The CA:FeX actors, when grouped with CA:Sec Secure Application, shall use the Authenticate Node [ITI-19] transaction to ensure secure communication between actors.

1.12.4 Canadian Audit Trail (CA:Aud) Grouping

The Reference Architecture provides specific Canadian implementation guidance for the implementation of the auditing aspect of the ATNA profile in Canada. For details, refer to the RA v0.1.1 DFT, section [Canadian Audit Trail \(CA:Aud\) Implementation Guidance](#).

CA:Aud provides support for Event Logging for Auditing. To allow for these features, CA:FeX actors can be grouped with CA:Aud actors.

If the grouping is in place, an actor from CA:FeX shall implement the required transactions and/or content modules in CA:FeX **in addition to all** the transactions required for the grouped actor (Column 2).

CA:FeX Actor	Actor(s) to be grouped with
Data Source	CA:Aud / Audit Creator
Data Recipient	CA:Aud / Audit Creator
Data Consumer	CA:Aud / Audit Creator
Data Responder	CA:Aud / Audit Creator

CA:FeX actors, when grouped with CA:Aud Audit Creator, shall use the Record Audit Event [ITI-20] transaction to send audit event log messages to an Audit Record Repository.

1.13 CA:FeX Audit Considerations

To add support for audit, CA:FeX actors are recommended to be grouped with CA:Aud actors (see [Cross Profile Considerations / Canadian Audit Trail \(CA:Aud\) Grouping](#)).

Alternatively, other non-IHE methods can be used to record audit messages, that do not require grouping with CA:Aud actors.

The audit criteria are defined for each actor that participates in a CA:FeX transaction.

1.13.1 Submit Data [CA:FeX-1] Audit

The audit criteria are similar to other IHE transactions that export a document, such as [MHD Provide Document Bundle\[ITI-65\]](#) transaction.

Data Source Audit

The Data Source when grouped with CA:Aud Secure Node or Secure Application actor shall be able to record a Submit Data Source Audit Event Log.

Terminology Bindings

Path	Conformance	ValueSet / Code
AuditEvent.language	preferred	CommonLanguages Max Binding: AllLanguages
AuditEvent.type	extensible	Pattern: 110106("Export")
AuditEvent.subtype	extensible	Pattern: CA:FeX-1("Submit Data")
AuditEvent.action	required	Pattern: R
AuditEvent.outcome	required	AuditEventOutcome

AuditEvent.purposeOfEvent	extensible	PurposeOfUse
AuditEvent.agent.type	extensible	ParticipationRoleType
AuditEvent.agent.role	example	SecurityRoleType
AuditEvent.agent.media	extensible	MediaTypeCode
AuditEvent.agent.network.type	required	AuditEventAgentNetworkType
AuditEvent.agent.purposeOfUse	extensible	PurposeOfUse
AuditEvent.agent:dataSource.type	extensible	Pattern: 110153("Source Role ID")
AuditEvent.agent:dataSource.role	example	SecurityRoleType
AuditEvent.agent:dataSource.media	extensible	MediaTypeCode
AuditEvent.agent:dataSource.network.type	required	AuditEventAgentNetworkType
AuditEvent.agent:dataSource.purposeOfUse	extensible	PurposeOfUse
AuditEvent.agent:dataRecipient.type	extensible	Pattern: 110152("Destination Role ID")
AuditEvent.agent:dataRecipient.role	example	SecurityRoleType
AuditEvent.agent:dataRecipient.media	extensible	MediaTypeCode
AuditEvent.agent:dataRecipient.network.type	required	AuditEventAgentNetworkType
AuditEvent.agent:dataRecipient.purposeOfUse	extensible	PurposeOfUse
AuditEvent.source.type	extensible	AuditEventSourceType
AuditEvent.entity.type	extensible	AuditEventEntityType
AuditEvent.entity.role	extensible	AuditEventEntityRole

AuditEvent.entity.lifecycle	extensible	ObjectLifecycleEvents
AuditEvent.entity.securityLabel	extensible	All Security Labels
AuditEvent.entity:patient.type	extensible	Pattern: 1("Person")
AuditEvent.entity:patient.role	extensible	Pattern: 1("Patient")
AuditEvent.entity:patient.lifecycle	extensible	ObjectLifecycleEvents
AuditEvent.entity:patient.securityLabel	extensible	All Security Labels
AuditEvent.entity:submissionSet.type	extensible	Pattern: 2("System Object")
AuditEvent.entity:submissionSet.role	extensible	Pattern: 20("Job")
AuditEvent.entity:submissionSet.lifecycle	extensible	ObjectLifecycleEvents
AuditEvent.entity:submissionSet.security Label	extensible	All Security Labels

Data Recipient Audit

The Data Recipient when grouped with CA:Aud Secure Node or Secure Application actor shall be able to record a Submit Data Recipient Audit Event Log.

Terminology Bindings

Path	Conformance	ValueSet / Code
AuditEvent.language	preferred	CommonLanguages Max Binding: AllLanguages
AuditEvent.type	extensible	Pattern: 110107("Import")
AuditEvent.subtype	extensible	Pattern: CA:FeX-1("Submit Data")
AuditEvent.action	required	Pattern: C
AuditEvent.outcome	required	AuditEventOutcome
AuditEvent.purposeOfEvent	extensible	PurposeOfUse

AuditEvent.agent.type	extensible	ParticipationRoleType
AuditEvent.agent.role	example	SecurityRoleType
AuditEvent.agent.media	extensible	MediaTypeCode
AuditEvent.agent.network.type	required	AuditEventAgentNetworkType
AuditEvent.agent.purposeOfUse	extensible	PurposeOfUse
AuditEvent.agent:dataSource.type	extensible	Pattern: 110153("Source Role ID")
AuditEvent.agent:dataSource.role	example	SecurityRoleType
AuditEvent.agent:dataSource.media	extensible	MediaTypeCode
AuditEvent.agent:dataSource.network.type	required	AuditEventAgentNetworkType
AuditEvent.agent:dataSource.purposeOfUse	extensible	PurposeOfUse
AuditEvent.agent:dataRecipient.type	extensible	Pattern: 110152("Destination Role ID")
AuditEvent.agent:dataRecipient.role	example	SecurityRoleType
AuditEvent.agent:dataRecipient.media	extensible	MediaTypeCode
AuditEvent.agent:dataRecipient.network.type	required	AuditEventAgentNetworkType
AuditEvent.agent:dataRecipient.purposeOfUse	extensible	PurposeOfUse
AuditEvent.source.type	extensible	AuditEventSourceType
AuditEvent.entity.type	extensible	AuditEventEntityType
AuditEvent.entity.role	extensible	AuditEventEntityRole
AuditEvent.entity.lifecycle	extensible	ObjectLifecycleEvents

AuditEvent.entity.securityLabel	extensible	All Security Labels
AuditEvent.entity:patient.type	extensible	Pattern: 1("Person")
AuditEvent.entity:patient.role	extensible	Pattern: 1("Patient")
AuditEvent.entity:patient.lifecycle	extensible	ObjectLifecycleEvents
AuditEvent.entity:patient.securityLabel	extensible	All Security Labels
AuditEvent.entity:submissionSet.type	extensible	Pattern: 2("System Object")
AuditEvent.entity:submissionSet.role	extensible	Pattern: 20("Job")
AuditEvent.entity:submissionSet.lifecycle	extensible	ObjectLifecycleEvents
AuditEvent.entity:submissionSet.security Label	extensible	All Security Labels

1.13.2 Search Data [CA:FeX-2] Audit

The audit criteria are similar to those for the [MHD Find Document References \[ITI-67\]](#) transaction.

Data Consumer Audit

The Data Consumer when grouped with CA:Aud Secure Node or Secure Application actor shall be able to record a Search Data Consumer Audit Event Log.

Terminology Bindings

Path	Conformance	ValueSet / Code
AuditEvent.language	preferred	CommonLanguages Max Binding: AllLanguages
AuditEvent.type	extensible	Pattern: 110112("Query")
AuditEvent.subtype	extensible	Pattern: CA:FeX-2("Search Data")
AuditEvent.action	required	Pattern: E
AuditEvent.outcome	required	AuditEventOutcome

AuditEvent.purposeOfEvent	extensible	PurposeOfUse
AuditEvent.agent.type	extensible	ParticipationRoleType
AuditEvent.agent.role	example	SecurityRoleType
AuditEvent.agent.media	extensible	MediaTypeCode
AuditEvent.agent.network.type	required	AuditEventAgentNetworkType
AuditEvent.agent.purposeOfUse	extensible	PurposeOfUse
AuditEvent.agent:dataConsumer.type	extensible	Pattern: 110153("Source Role ID")
AuditEvent.agent:dataConsumer.role	example	SecurityRoleType
AuditEvent.agent:dataConsumer.media	extensible	MediaTypeCode
AuditEvent.agent:dataConsumer.network.type	required	AuditEventAgentNetworkType
AuditEvent.agent:dataConsumer.purposeOfUse	extensible	PurposeOfUse
AuditEvent.agent:dataResponder.type	extensible	Pattern: 110152("Destination Role ID")
AuditEvent.agent:dataResponder.role	example	SecurityRoleType
AuditEvent.agent:dataResponder.media	extensible	MediaTypeCode
AuditEvent.agent:dataResponder.network.type	required	AuditEventAgentNetworkType
AuditEvent.agent:dataResponder.purposeOfUse	extensible	PurposeOfUse
AuditEvent.source.type	extensible	AuditEventSourceType
AuditEvent.entity.type	extensible	AuditEventEntityType
AuditEvent.entity.role	extensible	AuditEventEntityRole

AuditEvent.entity.lifecycle	extensible	ObjectLifecycleEvents
AuditEvent.entity.securityLabel	extensible	All Security Labels
AuditEvent.entity:patient.type	extensible	Pattern: 1("Person")
AuditEvent.entity:patient.role	extensible	Pattern: 1("Patient")
AuditEvent.entity:patient.lifecycle	extensible	ObjectLifecycleEvents
AuditEvent.entity:patient.securityLabel	extensible	All Security Labels
AuditEvent.entity:queryParameters.type	extensible	Pattern: 2("System Object")
AuditEvent.entity:queryParameters.role	extensible	Pattern: 24("Query")
AuditEvent.entity:queryParameters.lifecycle	extensible	ObjectLifecycleEvents
AuditEvent.entity:queryParameters.securityLabel	extensible	All Security Labels

Data Responder Audit

The Data Responder when grouped with CA:Aud Secure Node or Secure Application actor shall be able to record a Search Data Consumer Audit Event Log.

Terminology Bindings

Path	Conformance	ValueSet / Code
AuditEvent.language	preferred	CommonLanguages Max Binding: AllLanguages
AuditEvent.type	extensible	Pattern: 110112("Query")
AuditEvent.subtype	extensible	Pattern: CA:FeX-2("Search Data")
AuditEvent.action	required	Pattern: E
AuditEvent.outcome	required	AuditEventOutcome

AuditEvent.purposeOfEvent	extensible	PurposeOfUse
AuditEvent.agent.type	extensible	ParticipationRoleType
AuditEvent.agent.role	example	SecurityRoleType
AuditEvent.agent.media	extensible	MediaTypeCode
AuditEvent.agent.network.type	required	AuditEventAgentNetworkType
AuditEvent.agent.purposeOfUse	extensible	PurposeOfUse
AuditEvent.agent:dataConsumer.type	extensible	Pattern: 110153("Source Role ID")
AuditEvent.agent:dataConsumer.role	example	SecurityRoleType
AuditEvent.agent:dataConsumer.media	extensible	MediaTypeCode
AuditEvent.agent:dataConsumer.network.type	required	AuditEventAgentNetworkType
AuditEvent.agent:dataConsumer.purposeOfUse	extensible	PurposeOfUse
AuditEvent.agent:dataResponder.type	extensible	Pattern: 110152("Destination Role ID")
AuditEvent.agent:dataResponder.role	example	SecurityRoleType
AuditEvent.agent:dataResponder.media	extensible	MediaTypeCode
AuditEvent.agent:dataResponder.network.type	required	AuditEventAgentNetworkType
AuditEvent.agent:dataResponder.purposeOfUse	extensible	PurposeOfUse
AuditEvent.source.type	extensible	AuditEventSourceType
AuditEvent.entity.type	extensible	AuditEventEntityType
AuditEvent.entity.role	extensible	AuditEventEntityRole

AuditEvent.entity.lifecycle	extensible	ObjectLifecycleEvents
AuditEvent.entity.securityLabel	extensible	All Security Labels
AuditEvent.entity:patient.type	extensible	Pattern: 1("Person")
AuditEvent.entity:patient.role	extensible	Pattern: 1("Patient")
AuditEvent.entity:patient.lifecycle	extensible	ObjectLifecycleEvents
AuditEvent.entity:patient.securityLabel	extensible	All Security Labels
AuditEvent.entity:queryParameters.type	extensible	Pattern: 2("System Object")
AuditEvent.entity:queryParameters.role	extensible	Pattern: 24("Query")
AuditEvent.entity:queryParameters.lifecycle	extensible	ObjectLifecycleEvents
AuditEvent.entity:queryParameters.securityLabel	extensible	All Security Labels

1.13.3 Retrieve Data [CA:FeX-3] Audit

The audit criteria are similar to those for the [MHD Retrieve Document \[ITI-68\]](#) transaction.

Data Consumer Audit

The Data Consumer when grouped with CA:Aud Secure Node or Secure Application actor shall be able to record a Retrieve Data Consumer Audit Event Log.

Terminology Bindings

Path	Conformance	ValueSet / Code
AuditEvent.language	preferred	CommonLanguages Max Binding: AllLanguages
AuditEvent.type	extensible	Pattern: 110107("Import")
AuditEvent.subtype	extensible	Pattern: CA:FeX-3("Retrieve Data")
AuditEvent.action	required	Pattern: C

AuditEvent.outcome	required	AuditEventOutcome
AuditEvent.purposeOfEvent	extensible	PurposeOfUse
AuditEvent.agent.type	extensible	ParticipationRoleType
AuditEvent.agent.role	example	SecurityRoleType
AuditEvent.agent.media	extensible	MediaTypeCode
AuditEvent.agent.network.type	required	AuditEventAgentNetworkType
AuditEvent.agent.purposeOfUse	extensible	PurposeOfUse
AuditEvent.agent:dataConsumer.type	extensible	Pattern: 110153("Source Role ID")
AuditEvent.agent:dataConsumer.role	example	SecurityRoleType
AuditEvent.agent:dataConsumer.media	extensible	MediaTypeCode
AuditEvent.agent:dataConsumer.network.type	required	AuditEventAgentNetworkType
AuditEvent.agent:dataConsumer.purposeOfUse	extensible	PurposeOfUse
AuditEvent.agent:dataResponder.type	extensible	Pattern: 110152("Destination Role ID")
AuditEvent.agent:dataResponder.role	example	SecurityRoleType
AuditEvent.agent:dataResponder.media	extensible	MediaTypeCode
AuditEvent.agent:dataResponder.network.type	required	AuditEventAgentNetworkType
AuditEvent.agent:dataResponder.purposeOfUse	extensible	PurposeOfUse
AuditEvent.source.type	extensible	AuditEventSourceType
AuditEvent.entity.type	extensible	AuditEventEntityType

AuditEvent.entity.role	extensible	AuditEventEntityRole
AuditEvent.entity.lifecycle	extensible	ObjectLifecycleEvents
AuditEvent.entity.securityLabel	extensible	All Security Labels
AuditEvent.entity:patient.type	extensible	Pattern: 1("Person")
AuditEvent.entity:patient.role	extensible	Pattern: 1("Patient")
AuditEvent.entity:patient.lifecycle	extensible	ObjectLifecycleEvents
AuditEvent.entity:patient.securityLabel	extensible	All Security Labels
AuditEvent.entity:documentUniqueId.what.type	extensible	ResourceType
AuditEvent.entity:documentUniqueId.type	extensible	Pattern: 2("System Object")
AuditEvent.entity:documentUniqueId.role	extensible	Pattern: 3("Report")
AuditEvent.entity:documentUniqueId.lifecycle	extensible	ObjectLifecycleEvents
AuditEvent.entity:documentUniqueId.securityLabel	extensible	All Security Labels

Data Responder Audit

The Data Responder when grouped with CA:Aud Secure Node or Secure Application actor shall be able to record a Retrieve Data Responder Audit Event Log.

Terminology Bindings

Path	Conformance	ValueSet / Code
AuditEvent.language	preferred	CommonLanguages Max Binding: AllLanguages
AuditEvent.type	extensible	Pattern: 110106("Export")
AuditEvent.subtype	extensible	Pattern: CA:FeX-3("Retrieve Data")

AuditEvent.action	required	Pattern: R
AuditEvent.outcome	required	AuditEventOutcome
AuditEvent.purposeOfEvent	extensible	PurposeOfUse
AuditEvent.agent.type	extensible	ParticipationRoleType
AuditEvent.agent.role	example	SecurityRoleType
AuditEvent.agent.media	extensible	MediaTypeCode
AuditEvent.agent.network.type	required	AuditEventAgentNetworkType
AuditEvent.agent.purposeOfUse	extensible	PurposeOfUse
AuditEvent.agent:dataConsumer.type	extensible	Pattern: 110153("Source Role ID")
AuditEvent.agent:dataConsumer.role	example	SecurityRoleType
AuditEvent.agent:dataConsumer.media	extensible	MediaTypeCode
AuditEvent.agent:dataConsumer.network.type	required	AuditEventAgentNetworkType
AuditEvent.agent:dataConsumer.purposeOfUse	extensible	PurposeOfUse
AuditEvent.agent:dataResponder.type	extensible	Pattern: 110152("Destination Role ID")
AuditEvent.agent:dataResponder.role	example	SecurityRoleType
AuditEvent.agent:dataResponder.media	extensible	MediaTypeCode
AuditEvent.agent:dataResponder.network.type	required	AuditEventAgentNetworkType
AuditEvent.agent:dataResponder.purposeOfUse	extensible	PurposeOfUse
AuditEvent.source.type	extensible	AuditEventSourceType

AuditEvent.entity.type	extensible	AuditEventEntityType
AuditEvent.entity.role	extensible	AuditEventEntityRole
AuditEvent.entity.lifecycle	extensible	ObjectLifecycleEvents
AuditEvent.entity.securityLabel	extensible	All Security Labels
AuditEvent.entity:patient.type	extensible	Pattern: 1("Person")
AuditEvent.entity:patient.role	extensible	Pattern: 1("Patient")
AuditEvent.entity:patient.lifecycle	extensible	ObjectLifecycleEvents
AuditEvent.entity:patient.securityLabel	extensible	All Security Labels
AuditEvent.entity:documentUniqueid.what.type	extensible	ResourceType
AuditEvent.entity:documentUniqueid.type	extensible	Pattern: 2("System Object")
AuditEvent.entity:documentUniqueid.role	extensible	Pattern: 3("Report")
AuditEvent.entity:documentUniqueid.lifecycle	extensible	ObjectLifecycleEvents
AuditEvent.entity:documentUniqueid.securityLabel	extensible	All Security Labels

2 Use Cases and Definitions

The purpose is to describe the use cases and workflow scenarios for sharing clinical documents across solutions. Each jurisdiction may have implementation variances within the use cases. Therefore, these use cases do not represent required implementation choices, nor are they representative of all possible implementation choices. These use cases are to be considered as examples. The use cases provide high-level interactions between a Health Care Provider or Patient using a Clinical Solution (e.g., EMR, Patient Portal, etc.) and the HIE. Use cases provide the business description or "conversation" between the system(s) and its user(s), known as Participants. Participants can be people (e.g., health care providers, patients, etc.) using a Clinical Solution (e.g., EMR, Patient Portal) or systems (e.g., HIE, etc.). Please note that detailed interactions are defined in the CA:FeX Interoperability Specifications [Sequence Diagrams](#) section of this document.

Each use case will include:

- use case scenario,
- examples of use case triggers, pre- and post-conditions,
- who the participants are (i.e., people and systems),
- a use case diagram to provide a visual representation of the interactions between participants,
- use case steps corresponding to the diagram and potential alternate flows, and
- requirements.

2.1 Use Case Index

This section includes a proposed list of use cases which were identified as being priority use cases in the pan-Canadian environmental scan. Additional use cases will be defined in future releases.

The scope for this release of the CA:FeX Specifications has been defined to include the following use cases:

The list below includes the use cases a Use Case ID, name and description of the use case.

Use Case ID	Use Case Name	Use Case Description
UC-01	Create and Submit Document	A Health Care Provider, in any care setting, adds Patient clinical documentation for use at point of care, which is made available to other authorized HCPs.
UC-02	Query and Retrieve Document	Query and retrieval of clinical documentation performed by a Health Care Provider for use at the point of care or by the Patient themselves to obtain a copy of their own personal health information.
UC-03	Create and Submit Data	A Health Care Provider, in any care setting, adds Patient clinical data for use at point of care, which is made available to other authorized HCPs.
UC-04	Query and Retrieve Data	Query and retrieval of clinical data performed by a Health Care Provider for use at the point of care or by the Patient themselves to obtain a copy of their own personal health information.

Use Case ID	Use Case Name	Use Case Description
UC-05	Fetch Document References	Clinical solution fetches references to clinical documentation from a Clinical Data Repository for use at the point of care or by the Patient themselves to obtain a copy of their own personal health information.

2.2 Requirement Priority Definitions

Priority	Definition
SHALL	<ul style="list-style-type: none"> used to indicate a required requirement.
SHOULD	<ul style="list-style-type: none"> used to indicate that a requirement is recommended and should be considered as best practice for implementation, but not required (i.e., it is optional) for implementation.

2.3 UC-01 Create and Submit Document

Description

A Health Care Provider, in any care setting, adds Patient clinical documentation for use at point of care, which is made available to other authorized HCPs.

Scenario

A patient schedules a visit with their regular health care provider, within their Medical Home, with symptoms including dizziness and an earache. The patient mentions that since they last visited, another clinic noted that they have high blood pressure (hypertension) which is being monitored at home for now. The patient also mentions a suspected penicillin allergy. The health care provider determines that the patient has an external ear infection (otitis externa) and prescribes antibiotics. The health care provider creates a clinical note in their EMR, which may trigger automatic updates, such as updates to the prescription information. The health care provider decides to submit this new information to the network (i.e., Clinical Data Repository) in the form of a clinical document (e.g., patient summary) so that it is available for other health care providers who may be providing care for this patient.

Triggers, Pre-conditions, Post-Conditions

This section describes example triggers, pre-conditions & post-conditions related to uploading new clinical documents to the Clinical Data Repository. It is not inclusive of all potential workflow scenarios which may be implemented within Canadian jurisdictions.

Triggers

- Health Care Provider provides care to a patient and adds clinical information to the Patient's record.

- Health Care Provider receives additional information for a patient that they wish to share with other HCPs. For example, HCP receives test results for a Patient and adds the clinical information to the Patient's problem list.

Pre-conditions

- Clinical documentation shall uniquely identify the Patient so that it can be uploaded to the Clinical Data Repository and available to other HCPs (e.g., uniquely identified by a Client Registry ID)
- In jurisdictions where explicit consent is required to share Patient clinical documentation:
 - Patient provides, or has previously provided, consent to share their data to the Clinical Data Repository.

Post-conditions

- New Patient clinical documentation recorded/registered in the Clinical Data Repository.
- Authorized health care providers have access to view the Patient's clinical documentation or may receive a notification that new clinical documentation about the patient is available.

Use Case Participants & Diagram

The participants involved in this use case are:

- Data Source (Health Care Provider adding patient clinical documentation via their local Clinical Solution (e.g., EMR))
- Data Recipient (Clinical Data Repository receiving/storing the Patient's clinical documentation)

This use case diagram represents the participants and their role in the use case with a high-level view of the flow of information.

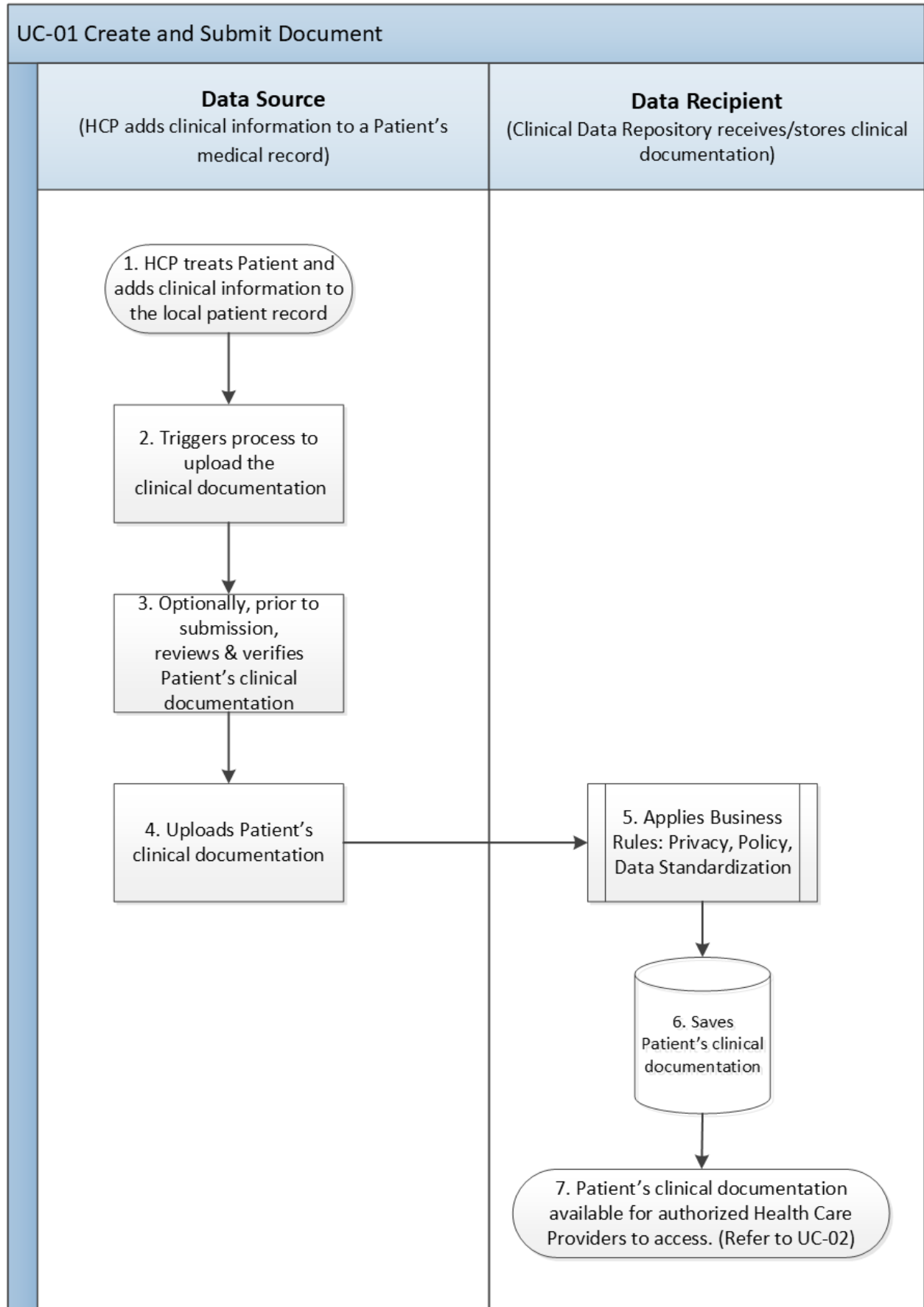

Use Case - Primary Flow

The following provides a textual description corresponding to the use case diagram.

1. Health Care Provider treats Patient and adds clinical information to the Patient's health record in their local Clinical Solution (e.g., EMR, HIS).
2. Health Care Provider decides to share the new clinical information collected in the form of a document and triggers the process to upload the document to the Clinical Data Repository.
3. Health Care Provider, optionally, reviews and validates the Patient's clinical documentation prior to sharing/ uploading it to the Clinical Data Repository.
4. Health Care Provider sends / uploads the Patient's clinical documentation to the Clinical Data Repository.
5. Clinical Data Repository applies business rules (e.g. data standardization, privacy, policy, etc.).
For example:
 - a. Validation of Patient Summary data (e.g. Provider identified and eligible to submit clinical documentation, Patient identified, etc.)
 - b. Checks for existing clinical documentation for same patient/same provider - apply replacement / archiving rules
6. Clinical Data Repository saves the Patient's clinical documentation.
 - a. Clinical Data Repository responds to the submitting system to indicate that the submission was accepted (i.e., recorded/registered) or it was a bad request.
7. Patient's clinical documentation is available for access by authorized Health Care Providers. (Refer to UC-02 Query and Retrieve Document)

Use Case - Alternate Flow

The following list provides possible alternate flows that may occur within this use case but are currently considered out of scope for the defined transactions in this release. Reviewers are encouraged to provide feedback on the prioritization of these alternate flows for future releases.

- Step 3: Health Care Provider has the option to bypass an additional review of the clinical documentation, allowing the Clinical Solution to automatically share/upload the clinical documentation to the Clinical Data Repository.
- Step 3: Health Care Provider, upon review of the clinical documentation, chooses to make changes within the local Patient's health record prior to uploading it to the Clinical Data Repository.
- Step 4: Health Care Provider, after submitting the Patient's clinical documentation, identifies that there is incorrect or missing information. The HCP will have the option to modify and upload the corrected clinical documentation to the Clinical Data Repository.
- Step 4: Health Care Provider, after submitting the Patient's clinical documentation, identifies that incorrect information has been uploaded (e.g., information is for the wrong patient). The HCP will have the option to retract / delete the documentation from the Clinical Data Repository.

Use Case - Requirements

The following is a list of key requirements that will be addressed as part of this use case.

#	Category	Requirement Description
1	Write	FHIR API SHALL be capable of accepting write operations to allow creation of new clinical document in the central Clinical Data Repository
2	Response	FHIR API SHALL be capable of returning a response that a new clinical documentation has been successfully recorded/registered in the central Clinical Data Repository
3	Response	FHIR API SHALL be capable of returning a response that a Patient clinical documentation could not be recorded/registered in the central Clinical Data Repository (HTTP 400 - Bad Request)

2.4 UC-02 Query and Retrieve Document

Description

Query and retrieval of clinical documentation performed by a Health Care Provider for use at the point of care or by the Patient themselves to obtain a copy of their own personal health information.

Scenario

The following are example scenarios. It is not inclusive of all potential scenarios which may be implemented within Canadian jurisdictions.

1) A Health Care Provider, in any care setting, queries and retrieves a clinical document for use at the point of care

A patient schedules a visit with a health care provider, outside of their Medical Home, with symptoms including dizziness and an earache. The patient mentions that they have a regular health care provider, within their Medical Home, and experiences high blood pressure (hypertension) which is being monitored at home for now. The health care provider collects information from the patient and, using their Clinical Solution (e.g., EMR), searches for clinical information (e.g., searches the network to locate clinical documentation created and shared by another Health Care Provider). Upon finding a clinical document(s) for their patient, the health care provider views and uses the information in support of providing care for this patient.

2) A Patient or Subject of Care accesses/views and can obtain a copy of their own personal health information

A patient, or their designated caregiver, would like to access their personal health information (PHI) to stay up to date with their medical health information, empowering them to play an active role in their own care.

Triggers, Pre-conditions, Post-conditions

This section describes example triggers, pre-conditions & post-conditions related to the query and retrieval of clinical document(s) from the Clinical Data Repository. It is not inclusive of all potential workflow scenarios which may be implemented within Canadian jurisdictions.

Triggers

Scenario 1:

- Patient visits Health Care Provider for care.
- Where applicable, HCP received a notification that new clinical information is available for the Patient to which they have subscribed to receive notifications.

Scenario 2:

- Patient, or their designated caregiver, chooses to view personal health information to stay informed of their medical information.
- Patient wants to obtain a copy of their personal health information to have on their person while travelling.
- Patient wants to obtain a copy of their personal health information to share with another care provider.

Pre-conditions

Scenario 1:

- Health Care Provider is logged in to their Clinical Solution (e.g., EMR).
- Health Care Provider's Clinical Solution is connected / part of the Clinical Data Repository network.

Scenario 2:

- In jurisdictions where a patient may have applied consent directives to their clinical information, HCP complies with local/jurisdictional privacy policies.
- A jurisdictional clinical system with patient access is available.
- If applicable, patient has designated and authorized a designated caregiver to access their personal health record on their behalf.

Post-conditions

Scenario 1:

- Health Care Provider views and uses the clinical document(s) in support of Patient care.

Scenario 2:

- Patient, or their designated caregiver, accessed/viewed, and optionally printed a copy of, their personal health information.
- Patient, or their designated caregiver, presents their personal health information to another health care provider to support continuity of care.

Use Case Participants & Diagram

The participants involved in this use case are:

- Data Consumer (Clinical Solution, e.g., EMR used by the Health Care Provider to request & retrieve access to clinical document(s) from the Clinical Data Repository; Patient Portal used by the Patient / Subject of Care to request & retrieve access to their clinical document(s) from the Clinical Data Repository)
- Data Responder (Health Records System acting as the Clinical Data Repository enabling access and responding with the requested clinical document(s))

This use case diagram represents the participants and their role in the use case with a high-level view of the flow of information.

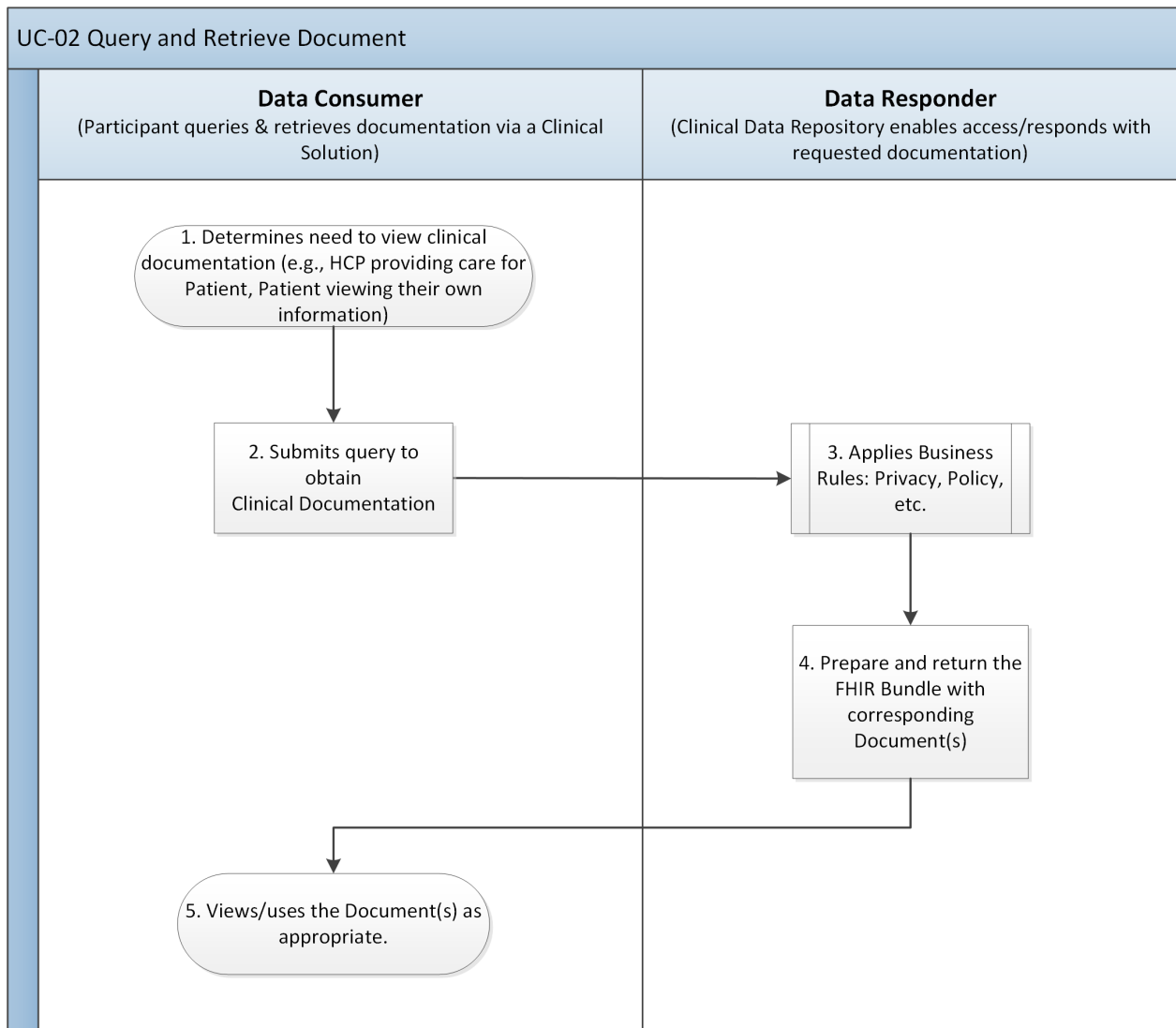

Use Case - Primary Flow

The following provides a textual description corresponding to the use case diagram.

1. Participant (i.e., Health Care Provider or Patient / Subject of Care) determines need to view clinical information.
2. Participant requests access (i.e., queries) for clinical information via the clinical solution.
3. Clinical Data Repository applies applicable business/policy rules (e.g. validates requestors credentials).
4. Clinical Data Repository prepares and returns the FHIR bundle with corresponding clinical document(s).
5. Participant views/uses the clinical document(s) in support of care for the Patient or themselves.

Use Case - Alternate Flow

The following list provides possible alternate flows that may occur within this use case but are currently considered out of scope for the defined transactions in this release. Reviewers are encouraged to provide feedback on the prioritization of these alternate flows for future releases.

- Step 3: Patient Consent Services are not currently supported in the CA:FeX specifications. However, Patient consent is considered as a roadmap item and would be represented in a separate use case at that time where a Patient has identified consent directives requiring the Health Care Provider to address prior to accessing the Patient's clinical information. It is recognized that some jurisdictions may have existing Patient Consent Services implemented and should be considered when implementing in that jurisdiction.

Use Case - Requirements

The following is a list of key requirements that will be addressed as part of this use case.

#	Category	Requirement Description
1	Query	FHIR API SHALL be capable of executing searches based on a Patient Resource ID
2	Query	FHIR API SHALL be capable of executing chained searches based on a Patient Identifier
3	Query	FHIR API SHALL be capable of executing searches as they are defined in the CA:FeX Server Capability Statement
5	Query	FHIR API SHALL be capable of accepting requests originating from a patient portal or any other system that allows a patient to initiate a request to access their personal health information (PHI)
6	Response	FHIR API SHALL be capable of responding to requests for retrieval of clinical information for requests initiated by patient to access their PHI

2.5 UC-03 Create and Submit Data

Description

A Health Care Provider, in any care setting, adds Patient clinical data for use at point of care, which is made available to other authorized HCPs.

Scenario

A middle-aged patient schedules their yearly physical with their regular health care provider, within their Medical Home. As part of their physical, the patient undergoes routine blood tests (e.g., Hemoglobin A1C, Standard Lipid Panel). The A1C test results show above normal levels (6.0%). During the encounter with the patient, the health care provider adds Prediabetes on the Patient's problem list in the EMR. Upon saving a new problem to the patient's record, a prompted or automatic trigger occurs in the background to update the provincial clinical data repository so that the patient's new condition is available for other health care providers to view who may be providing care for this patient.

Triggers, Pre-conditions, Post-Conditions

This section describes example triggers, pre-conditions & post-conditions related to uploading new clinical information to the Clinical Data Repository. It is not inclusive of all potential workflow scenarios which may be implemented within Canadian jurisdictions.

Triggers

- Health Care Provider provides care to a patient and adds clinical information to the Patient's record.
- Health Care Provider receives additional information for a patient that they wish to share with other HCPs.

Pre-conditions

- Clinical data shall uniquely identify the Patient so that it can be uploaded to the Clinical Data Repository and available to other HCPs (e.g., uniquely identified by a Client Registry ID)
- In jurisdictions where explicit consent is required to share Patient clinical data:
 - Patient provides, or has previously provided, consent to share their data to the Clinical Data Repository.

Post-conditions

- New Patient clinical data recorded/registered in the Clinical Data Repository.
- Authorized health care providers have access to view the Patient's clinical data or may receive a notification that new clinical data about the patient is available.

Use Case Participants & Diagram

The participants involved in this use case are:

- Data Source (Health Care Provider adding patient clinical data via their local Clinical Solution (e.g., EMR))
- Data Recipient (Clinical Data Repository receiving/storing the Patient's clinical data)

This use case diagram represents the participants and their role in the use case with a high-level view of the flow of information.

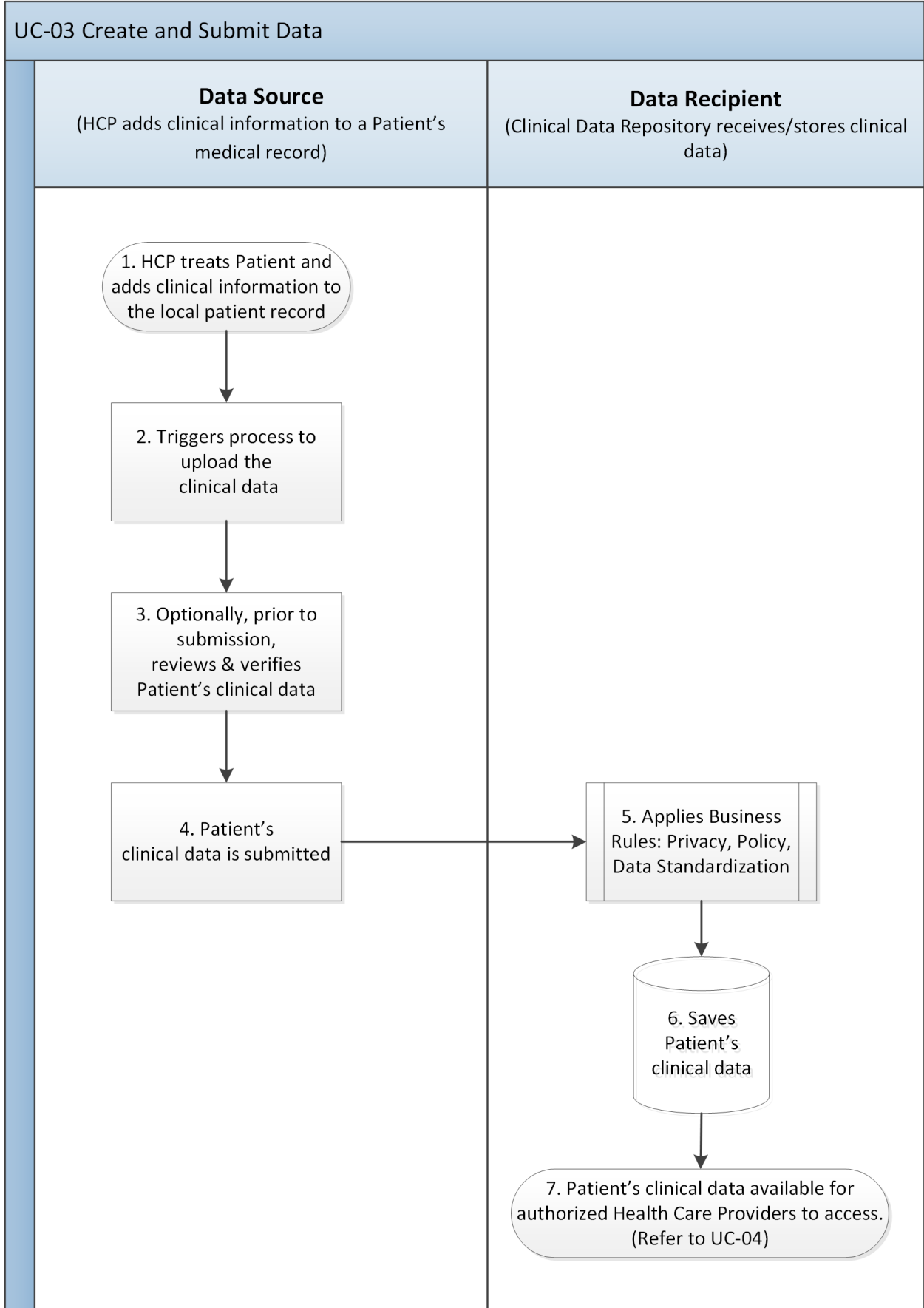

Use Case - Primary Flow

The following provides a textual description corresponding to the use case diagram.

1. Health Care Provider treats Patient and adds clinical information to the Patient's health record in their local Clinical Solution (e.g., EMR, HIS).
2. Health Care Provider decides to share the new clinical data collected and triggers the process to upload the data to the Clinical Data Repository.
3. Health Care Provider, optionally, reviews and validates the Patient's clinical data prior to sharing/uploading it to the Clinical Data Repository.
4. Health Care Provider sends / uploads the Patient's clinical data to the Clinical Data Repository.
5. Clinical Data Repository applies business rules (e.g. data standardization, privacy, policy, etc.).
6. Clinical Data Repository saves the Patient's clinical data.
 - a. Clinical Data Repository responds to the submitting system to indicate that the submission was accepted (i.e., recorded/registered) or it was a bad request.
7. Patient's clinical data is available for access by authorized Health Care Providers. (Refer to UC-04 Query and Retrieve Document)

Use Case - Alternate Flow

The following list provides possible alternate flows that may occur within this use case but are currently considered out of scope for the defined transactions in this release. Reviewers are encouraged to provide feedback on the prioritization of these alternate flows for future releases.

- Step 3: Health Care Provider has the option to bypass an additional review of the clinical information, allowing the Clinical Solution to automatically submit/upload the clinical data to the Clinical Data Repository.
- Step 3: Health Care Provider, upon review of the clinical information, chooses to make changes within the local Patient's health record prior to uploading the clinical data to the Clinical Data Repository.
- Step 4: Health Care Provider, after submitting the Patient's clinical data, identifies that there is incorrect or missing information. The HCP will have the option to modify and upload the corrected clinical data to the Clinical Data Repository.
- Step 4: Health Care Provider, after submitting the Patient's clinical data, identifies that incorrect information has been uploaded (e.g., information is for the wrong patient). The HCP will have the option to retract / delete the data from the Clinical Data Repository.

Use Case - Requirements

The following is a list of key requirements that will be addressed as part of this use case.

#	Category	Requirement Description
1	Write	FHIR API SHALL be capable of accepting write operations to allow creation of new clinical data (e.g., FHIR Resources) in the central Clinical Data Repository

#	Category	Requirement Description
2	Response	FHIR API SHALL be capable of returning a response that a new clinical data has been successfully recorded/registered in the central Clinical Data Repository
3	Response	FHIR API SHALL be capable of returning a response that a Patient clinical data could not be recorded/registered in the central Clinical Data Repository (HTTP 400 - Bad Request)

2.6 UC-04 Query and Retrieve Data

Description

Query and retrieval of clinical data performed by a Health Care Provider for use at the point of care or by the Patient themselves to obtain a copy of their own personal health information (PHI).

Scenario

The following are example scenarios. It is not inclusive of all potential scenarios which may be implemented within Canadian jurisdictions.

1) A Health Care Provider, in any care setting, queries and retrieves a clinical information for use at the point of care

A patient has a visit with an urgent care provider, outside of their Medical Home, with intense redness and mild discharge in her left eye. After collecting information about the patient in their Clinical Solution (e.g., EMR), the health care provider suspects the patient has bacterial conjunctivitis. Before prescribing an optic antibiotic the health care provider wants to ensure they know the full list of potential allergies the patient may have. Using their Clinical Solution, the health care provider searches for clinical data (e.g., searches the network to locate clinical data created and shared by another Health Care Provider) for information on the Patient's active allergies and conditions. Upon finding a clinical data for their patient, the health care provider views and uses the clinical data in support of providing care for this patient.

2) A Patient or Subject of Care accesses/views and can obtain a copy of their own personal health information

A patient, or their designated caregiver, would like to access their clinical data to stay up to date with their medical health information, empowering them to play an active role in their own care.

Triggers, Pre-conditions, Post-conditions

This section describes example triggers, pre-conditions & post-conditions related to the query and retrieval of clinical data from the Clinical Data Repository. It is not inclusive of all potential workflow scenarios which may be implemented within Canadian jurisdictions.

Triggers

Scenario 1:

- Patient visits Health Care Provider for care.

Scenario 2:

- Patient, or their designated caregiver, chooses to view clinical data to stay informed of their medical information.
- Patient wants to obtain a copy of their clinical data to have on their person while travelling.
- Patient wants to obtain a copy of their clinical data to share with another care provider.

Pre-conditions

Scenario 1:

- Health Care Provider is logged in to their Clinical Solution (e.g., EMR).
- Health Care Provider's Clinical Solution is connected / part of the Clinical Data Repository network.
- In jurisdictions where a patient may have applied consent directives to their clinical data, HCP complies with local/jurisdictional privacy policies.

Scenario 2:

- A jurisdictional clinical system with patient access is available.
- If applicable, patient has designated and authorized a designated caregiver to access the clinical data on their behalf.

Post-conditions

Scenario 1:

- Health Care Provider views and uses the clinical data in support of Patient care.

Scenario 2:

- Patient, or their designated caregiver, accessed/viewed, and optionally printed a copy of, their clinical data
- Patient, or their designated caregiver, presents their clinical data to another health care provider to support continuity of care.

Use Case Participants & Diagram

The participants involved in this use case are:

- Data Consumer (Clinical Solution, e.g., EMR used by the Health Care Provider to request & retrieve access to clinical data from the Clinical Data Repository; Patient Portal used by the Patient / Subject of Care to request & retrieve access to their clinical data from the Clinical Data Repository)
- Data Responder (Health Records System acting as the Clinical Data Repository enabling access and responding with the requested clinical data)

This use case diagram represents the participants and their role in the use case with a high-level view of the flow of information.

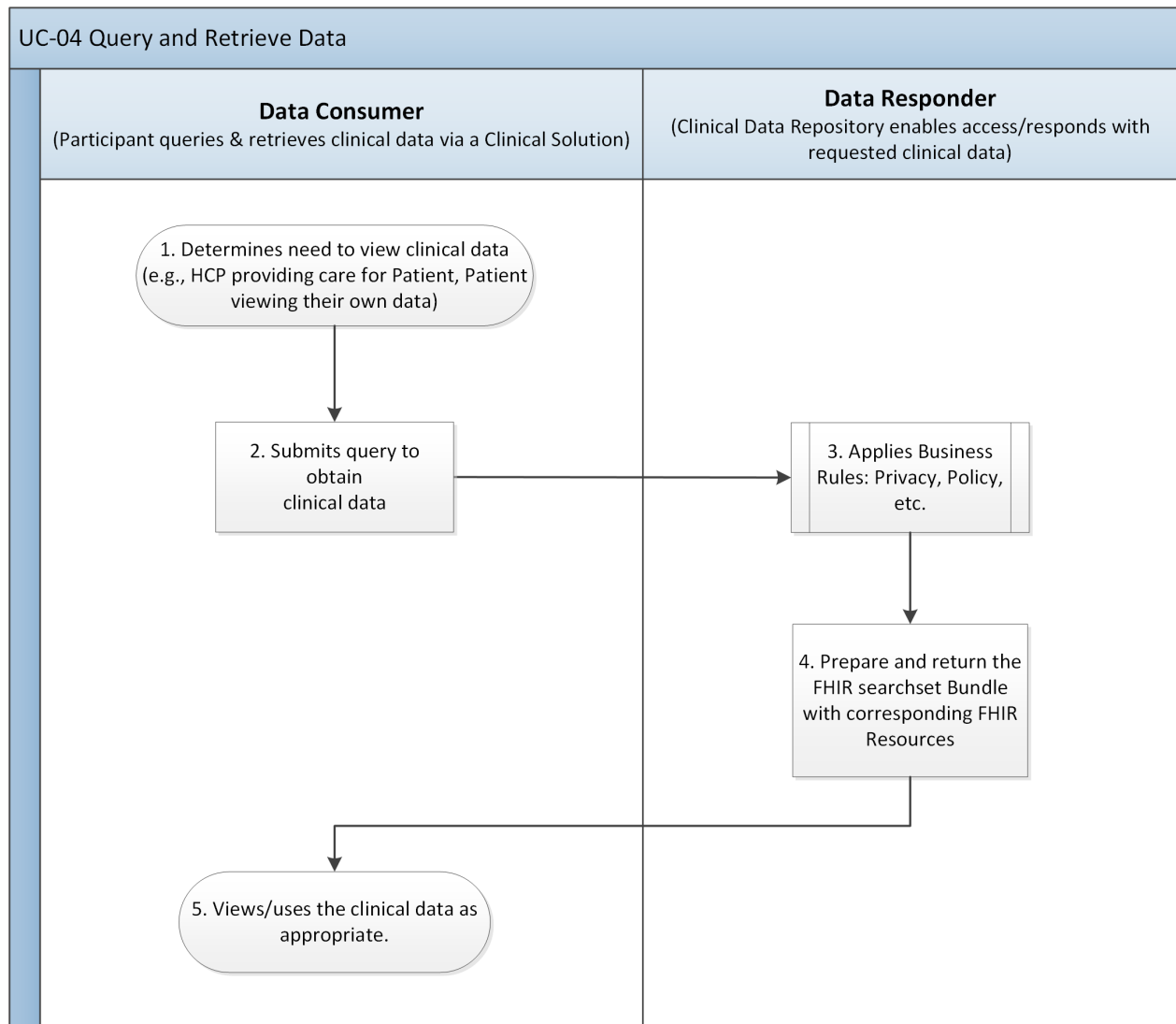

Use Case - Primary Flow

The following provides a textual description corresponding to the use case diagram.

1. Participant (i.e., Health Care Provider or Patient / Subject of Care) determines need to view clinical data.
2. Participant requests access (i.e., queries) for clinical data via the clinical solution.
3. Clinical Data Repository applies applicable business/policy rules (e.g. validates requestors credentials).
4. Clinical Data Repository prepares and returns the FHIR searchset bundle with corresponding clinical data.
5. Participant views/uses the clinical data in support of care for the Patient or themselves.

Use Case - Alternate Flow

The following list provides possible alternate flows that may occur within this use case but are currently considered out of scope for the defined transactions in this release. Reviewers are encouraged to provide feedback on the prioritization of these alternate flows for future releases.

- Step 3: Patient Consent Services are not currently supported in the CA:FeX specifications. However, Patient consent is considered as a roadmap item and would be represented in a separate use case at that time where a Patient has identified consent directives requiring the Health Care Provider to address prior to accessing the Patient's clinical data. It is recognized that some jurisdictions may have existing Patient Consent Services implemented and should be considered when implementing in that jurisdiction.

Use Case - Requirements

The following is a list of key requirements that will be addressed as part of this use case.

#	Category	Requirement Description
1	Query	FHIR API SHALL be capable of executing searches based on a Patient Resource ID
2	Query	FHIR API SHOULD be capable of executing chained searches based on a Patient Identifier (e.g., jurisdictional health number)
3	Query	FHIR API SHALL be capable of executing searches as they are defined in the CA:FeX Server Capability Statement
4	Query	FHIR API SHALL be capable of accepting requests originating from a patient portal or any other system that allows a patient to initiate a request to access their personal health information (PHI)
5	Response	FHIR API SHALL be capable of responding to requests for retrieval of clinical data for requests initiated by patient to access their PHI

2.7 UC-05 Fetch Document References

Description

Fetch of references to clinical documentation performed by a Health Care Provider for use at the point of care or by the Patient themselves to obtain a copy of their own personal health information.

This use case allows the requester to review the information describing the document(s) that are available for the Health Care Provider or Patient to consume. This use case is intended to provide the requester with more control over what they fetch (e.g., if they don't want to receive every document in full that meets their criteria).

Fetch is also distinct from [UC-02 Query and Retrieve Document](#) because it is predicated on the Data Responder supporting a predefined FHIR Operation that allows a requester to provide more sophisticated input criteria that will impact how the Data Responder executes the request.

Scenario

The following are example scenarios. It is not inclusive of all potential scenarios which may be implemented within Canadian jurisdictions.

1) A Health Care Provider, fetches the references to a patient's existing clinical documents from a particular date range

A patient schedules a visit with a health care provider, outside of their Medical Home, with symptoms including dizziness and an earache. The patient mentions that they have a regular health care provider, within their Medical Home, and experiences high blood pressure (hypertension) which is being monitored at home for now. The health care provider collects information from the patient and, using their Clinical Solution (e.g., EMR), searches the network to locate references to clinical documentation created and shared by another Health Care Provider in the last three years.

The health care provider finds references to two documents for the patient, one from her primary care provider from six months ago, one from a past primary care provider that is three years old. Upon finding these references to clinical document(s) for their patient, the health care provider reviews the information describing the document(s) and decides to retrieve only the latest document from the primary care provider. The health care provider uses the information in support of providing care for this patient.

2) A Health Care Provider, fetches the references to a patient's clinical documents and indicates they would like documents that are generated on-demand

A patient schedules a visit with an urgent care health care provider, outside of their Medical Home, with symptoms including chest congestion and a crackling cough. The patient mentions that they have a regular health care provider, within their Medical Home. The health care provider collects information from the patient and, using their Clinical Solution (e.g., EMR), searches the network to locate references to clinical documentation created and shared by another Health Care Provider in the last three years.

The health care provider indicates that they would also like to receive any references to documents that were created on-demand in response to the health care provider's request.

The health care provider finds references to two documents for the patient, one that was generated on demand from her primary care provider's EMR that contains the most up-to-date information on the patient, and one that was shared following a visit from a specialist that the patient saw for a GI concern 18 months ago. Upon finding two references to clinical document(s) for their patient, the health care provider reviews the information describing the document(s) and decides to retrieve only the latest on-demand document from the primary care provider. The health care provider uses the information in support of providing care for this patient.

3) A Patient or Subject of Care fetches the references to a patient's existing clinical documents

A patient, or their designated caregiver, would like to access their personal health information (PHI) to stay up to date with their medical health information, empowering them to play an active role in their own care.

Triggers, Pre-conditions, Post-conditions

This section describes example triggers, pre-conditions & post-conditions related to the query and retrieval of clinical document(s) from the Clinical Data Repository. It is not inclusive of all potential workflow scenarios which may be implemented within Canadian jurisdictions.

Triggers

Scenario 1 & 2:

- Patient visits Health Care Provider for care.

Scenario 3:

- Patient, or their designated caregiver, chooses to view personal health information to stay informed of their medical information.
- Patient wants to obtain a copy of their personal health information to have on their person while travelling.
- Patient wants to obtain a copy of their personal health information to share with another care provider.

Pre-conditions

Scenario 1 & 2:

- Health Care Provider is logged in to their Clinical Solution (e.g., EMR).
- Health Care Provider's Clinical Solution is connected / part of the Clinical Data Repository network
- Health Care Provider's Clinical Solution knows the Resource ID of the patient from the Clinical Data Repository or Repository network or is requesting from a system that supports the optional use of a patient's identifier (system and value) to perform the FHIR Operation
- In jurisdictions where a patient may have applied consent directives to their clinical information, HCP complies with local/jurisdictional privacy policies.

Scenario 2:

- An EMR on the network has configured their system to support creation of the document on-demand

Scenario 3:

- A jurisdictional clinical system with patient access is available.
- If applicable, patient has designated and authorized a designated caregiver to access their personal health record on their behalf.

Post-conditions

Scenario 1 & 2:

- Health Care Provider views the references to the clinical document(s) and decides which ones to retrieve in support of patient care.
- Health Care Provider performs the Retrieve a Document transaction to retrieve the desired clinical document(s).
- Health Care Provider views the desired documents in support of patient care.

Scenario 3:

- Patient, or their designated caregiver, views the references to clinical document(s).
- Patient performs the Retrieve a Document transaction to retrieve the desired clinical document(s).
- Patient views the desired document(s), and optionally prints a copy of their personal health information.
- Patient, or their designated caregiver, presents their personal health information to another health care provider to support continuity of care.

Use Case Participants & Diagram

The participants involved in this use case are:

- Data Consumer (Clinical Solution, e.g., EMR used by the Health Care Provider to request & retrieve access to clinical document(s) from the Clinical Data Repository; Patient Portal used by the Patient / Subject of Care to request & retrieve access to their clinical document(s) from the Clinical Data Repository)
- Data Responder (Health Records System acting as the Clinical Data Repository enabling access and responding with the requested clinical document(s))

This use case diagram represents the participants and their role in the use case with a high-level view of the flow of information.

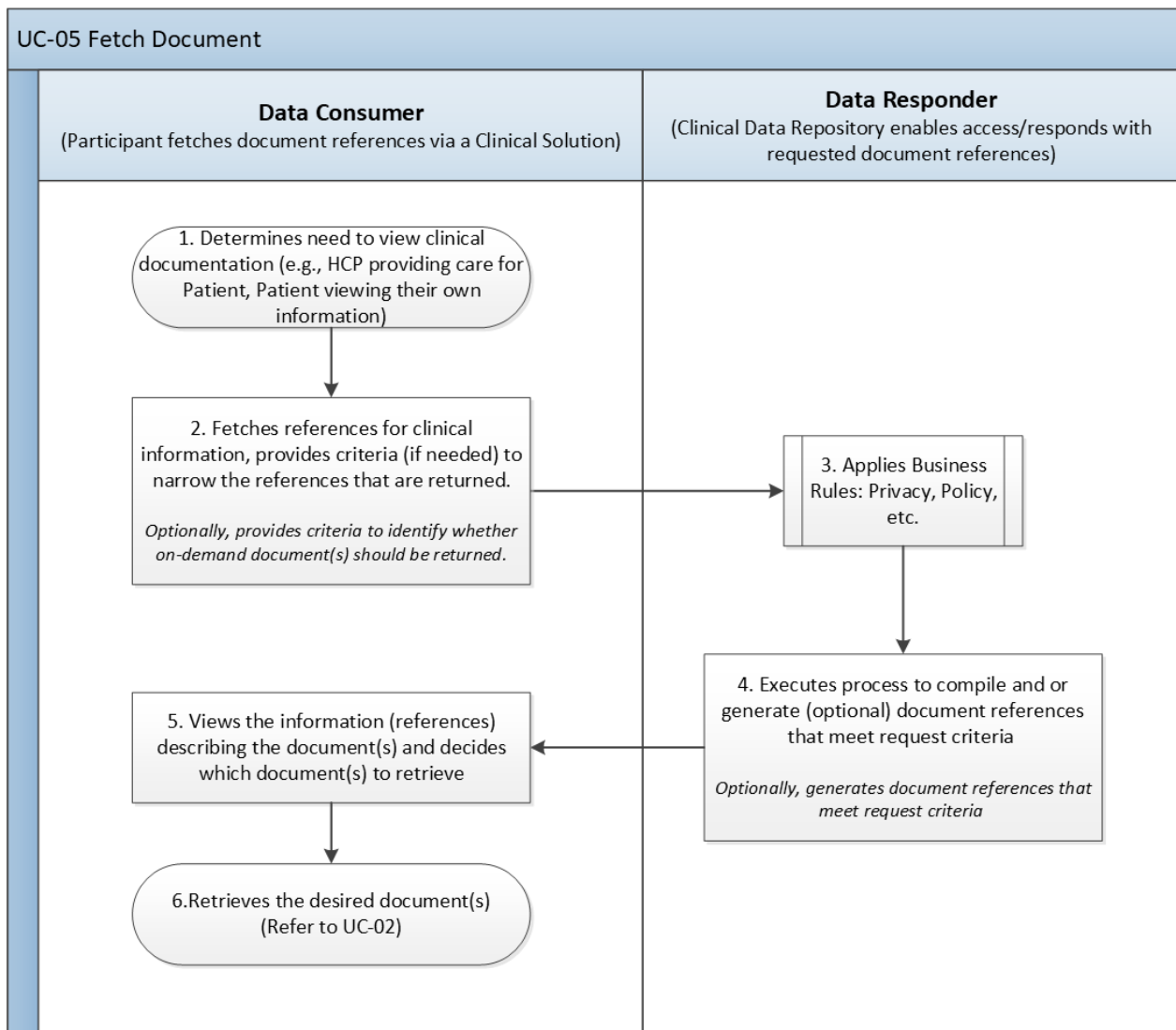

Use Case - Primary Flow

The following provides a textual description corresponding to the use case diagram.

1. Participant (i.e., Health Care Provider or Patient / Subject of Care) determines need to view clinical information.

2. Participant fetches references for clinical information via the clinical solution, providing criteria (if needed) to narrow the clinical document references that are returned.
3. Clinical Data Repository applies applicable business/policy rules (e.g. validates requestors credentials).
4. Clinical Data Repository prepares and returns the references to the available clinical document(s) that correspond to the request criteria.
5. Participant uses the information in the document references to identify the clinical document(s) they would like to retrieve.
6. Participant retrieves the desired document(s) in support of care for the Patient or themselves.

Use Case - Alternate Flow

The following list provides possible alternate flows that may occur within this use case but are currently considered out of scope for the defined transactions in this release. Reviewers are encouraged to provide feedback on the prioritization of these alternate flows for future releases.

- Step 2: Participant identifies that they would like to additionally receive references to documents that are generated on-demand in response to the fetch request
- Step 3: Patient Consent Services are not currently supported in the CA:FeX specifications. However, Patient consent is considered as a roadmap item and would be represented in a separate use case at that time where a Patient has identified consent directives requiring the Health Care Provider to address prior to accessing the Patient's clinical information. It is recognized that some jurisdictions may have existing Patient Consent Services implemented and should be considered when implementing in that jurisdiction.
- Step 4: Clinical Data Repository generates document references that meet request criteria.

Use Case - Requirements

The following is a list of key requirements that will be addressed as part of this use case.

#	Category	Requirement Description
1	Fetch	FHIR API SHALL be capable of executing the FHIR Operation based on a Patient Resource ID
2	Fetch	FHIR API SHOULD be capable of executing the FHIR Operation based on a Patient's identifier (e.g., jurisdictional health number)
3	Fetch	FHIR API SHOULD be capable of executing the FHIR Operation based on a specified date range
5	Fetch	FHIR API SHOULD be capable of executing the FHIR Operation based on specific a Document Type that the health care provider is interested in retrieving

#	Category	Requirement Description
6	Fetch	FHIR API MAY be capable of executing the FHIR Operation based on a specific Document Category (e.g., type of service) that the health care provider is interested in retrieving
7	Response	FHIR API SHALL be capable of returning a "searchset" Bundle that includes document references that match the provided parameters
8	Response	FHIR API SHALL be capable of returning a "searchset" Bundle that is empty in the case where no document references can be returned based on provided parameters
9	Response	FHIR API MAY be capable of returning an OperationOutcome that provides additional details in the response

3 Exchanging Data & Documents in FHIR

- i** This specification initially limited its scope to the exchange of documents (and their respective resources) in FHIR. As the CA:FeX Interoperability Specifications evolve, it has been expanded to tackle the exchange of individual FHIR resources that can be exchanged independent of a document workflow (e.g., retrieval of last 3 years of dispensed medications).
With this expansion in scope, the guidance for exchanging information using FHIR has been migrated to the [Pan-Canadian FHIR Exchange \(CA:FeX\) IGuide](#).
Earlier versions of this specification can be found on the [CA:FeX Release Information](#) page.

3.1 Overview

The CA:FeX specification package was developed to define and guide approaches to information sharing using FHIR RESTful capabilities primarily for (but not limited to) greenfield implementations. Expectations in CA:FeX will be rooted in best practices from international FHIR specifications (e.g., IPA, QEDm, US Core, IPS, etc.) that are feasible for the Canadian market to standardize around.

At a glance, CA:FeX will provide guidance in the following areas:

- Single Resource Exchange: RESTful exchange behaviors and identification of the capabilities (read, search, create, update, and delete) and subset of FHIR resource types that systems are expected support single resource exchanges
- Multiple Resource Exchange: Approaches for exchanging multiple resources together in the form of documents, and identification of standardized search parameters and practices for document implementers to incorporate into guides and systems
- Extending APIs with FHIR Operations: Identification of functional FHIR operations that allow implementers to abstract complexity away from requesting applications, by offering a single API call that can trigger multi-step processes to execute

The CA:FeX specification package is intended to act as a key building block within the arsenal of interoperability tools that provide vendors with the ability to anticipate or predict the minimum expectation to interact with any ecosystem interface, regardless of jurisdiction. In line with international peers, it will act as the guidance to define “Interaction Support” for all health IT ecosystem players.

This guidance has been migrated to the [Pan-Canadian FHIR Exchange \(CA:FeX\) IGuide](#).

Scope

This specification initially targeted the exchange of FHIR Documents.

The current version of CA:FeX is focused on the FHIR RESTful exchange of documents, single-resource exchange (e.g., retrieval of last 3 years of dispensed medications), and the execution of transactions. CA:FeX aims to provide clarity to implementers by identifying some of the choices currently available using FHIR, ranging from simple to a higher level of sophistication.

3.2 Transactions

IHE Transactions are interactions between actors that communicate the required information through standards-based messages (e.g., patient look-up query, send patient summary information, etc.). Established CA:FeX Transactions (i.e., CA:FeX-1 Submit Data, CA:FeX-2 Search Data, CA:FeX-3 Retrieve Data) were intended to be generic enough to describe the interaction pattern between actors participating in FHIR exchange. However, early scoping of CA:FeX to identify document exchange requirements resulted in a need to differentiate how the transactions could be specialized for a given context.

For example, the search behavior and FHIR Resources making up the payload returned from a FHIR Assembled Documents Repository are expected to be different from the search behavior and payload returned from a Hybrid Documents Repository that may contain legacy Binary documents as well as FHIR Documents. This resulted in the need to specialize the transactions to describe these differences (e.g., CA:FeX-3A: Retrieve Document From FHIR Assembled Documents Repository and CA:FeX-3B: Retrieve Document From Hybrid Documents Repository).

Note: The inclusion of Single Resource Exchange and Extending APIs with FHIR Operations in the scope of this release has been introduced pre-emptively to allow the specification to scale to implementer needs. However, the need for further specialized transactions for exchange of certain types of discrete data (e.g., allergies, practitionerRole) or for certain types of FHIR Operations, is yet to be assessed.

The following table has been provided to describe the interaction between Use Cases, Transactions, and Specializations.

Use Case ID	Transaction ID	Additional Details (Transaction Specializations):
UC-01 Create and Submit Document	CA:FeX-1 Submit Data	N/A
UC-02 Query and Retrieve Document	CA:FeX-2 Search Data	CA:FeX-2A: Search Against FHIR Assembled Documents Repository

Use Case ID	Transaction ID	Additional Details (Transaction Specializations):
	CA: FeX-3 Retrieve Data	CA:FeX-3A: Retrieve Document From FHIR Assembled Documents Repository
UC-03 Create and Submit Data	CA: FeX-1 Submit Data	N/A
UC-04 Query and Retrieve Data	CA: FeX-2 Search Data	N/A
	CA: FeX-3 Retrieve Data	N/A

Use Case ID	Transaction ID	Additional Details (Transaction Specializations):
UC-05 Fetch Document References	CA:FeX-2 Search Data	CA:FeX-2B: Search Against Hybrid Documents Repository
	CA:FeX-3 Retrieve Data	CA:FeX-3A: Retrieve Document From FHIR Assembled Documents Repository, CA:FeX-3B: Retrieve Document From Hybrid Documents Repository

3.3 FHIR Version

FHIR content in this specification is based on [FHIR Release 4](#) (v4.0.1).